

# The No. 1 for Garden Sheds, Boxes, Planting Beds & More



HighLine® size H2, metallic dark grey (with aluminium floor frame, aluminium floor panels, door baskets, window unit and double door as accessories)





Storage



Gardening





Outdoor  
Living



**Biohort**  
For outdoors,  
forever.

**Garden Sheds**

10



**12** Europa  
**24** Accessories



**14** AvantGarde® /  
AvantGarde®ECO  
**24** Accessories



**16** HighLine®  
**24** Accessories



**18** Panorama®  
**24** Accessories



**20** Neo  
**24** Accessories



**22** CasaNova®



**28** BikeLift®



**30** Foundation  
Solutions SmartBase /  
SmartBase<sup>PLUS</sup>

**Outdoor Lockers**

34



**36** Equipment  
Locker  
**24** Accessories



**38** Romeo®  
Patio Locker



**40** Julia®  
Patio Locker



**42** WoodStock®

**Outdoor Boxes**

44



**46** LeisureTime  
Box



**48** StyleBox®



**50** LoungeBox®



**52** StoreMax®



**54** HighBoard

**Bike Storage**

56



**58** MiniGarage



**60** StoreMax®



**62** HighBoard

**Wheelie Bin Boxes**

64



**66** Alex®



**68** Alex® Duo



**70** StoreMax®



**72** HighBoard

**Outdoor Living**

74



**76** Pergola  
**78** Accessories



**80** CasaNova®



**82** Privacy Screen

**Greenhouses**

84



**86** Florentina  
Greenhouse  
**94** Accessories

**Planting Beds**

88



**90** Belvedere®  
**94** Accessories



**92** Raised Bed  
**94** Accessories



**96** DaVinci®

**Gardening Helpers**

98



**100** WoodStock®



**102** Charly®  
Robotic Lawnmower Garage



**103** MonAmi®

**Detailed Information**

104

# Biohort Product Variety



## Your Lasting Satisfaction – Our Family Promise

### Dear Customer!

Biohort products are made in Austria and stand for quality, durability and design. Our 20-year manufacturer's warranty reinforces this promise of quality.

As an Austrian manufacturer operating to the highest industrial standards, we rely on highly skilled professionals and state-of-the-art automated production processes. This is how products of the highest technical standard are created. We use only high-quality materials sourced from rigorously vetted suppliers. Our galvanized steel sheet comes from renowned steel mills in Austria and Germany – the same trusted by leading premium automotive manufacturers.

Our innovative strength is reflected not only in the continuous development of our products, but also in outstanding new creations: The Biohort Pergola, launched in 2025, was developed entirely in-house – from the first sketch to full-scale production – and was honoured with the internationally renowned Red Dot Award for outstanding design.

This is what we stand for – with the responsibility and passion of a family-run business.

Thank you for making Biohort a part of your home.

A handwritten signature in blue ink that reads "Priglinger".

Dipl.-Ing. Maximilian Priglinger, MLS<sup>wu</sup>  
Managing Director

A handwritten signature in blue ink that reads "J. Priglinger".

Dr. Josef Priglinger  
Company Founder

# The Biohort Full Service Package.

## All-In-One Solution

We guarantee our customers long-lasting satisfaction with our high-quality, durable products. In addition, we also offer you a complete service package. Our customer service team always handles your concerns personally and as quickly as possible. Thanks to our trained assembly partners, we can also guarantee the convenience of professional installation. The SmartBase and SmartBase<sup>PLUS</sup> foundation solutions are available for all sheds and can be installed significantly faster and cleaner than costly concrete foundations. Together with our online tools, such as the product configurator, Biohort offers the most comprehensive service on the market!



## Free Delivery\*

Dispatched within 2 to 4 days! We will deliver your order free of charge directly to your home address (delivery free kerbside). The given address must be accessible for a 38-t lorry (3 m minimum width of access).

\*applies to stock items only; excludes CasaNova®, CasaVita®, and oversized products.

## Assembly Service

Biohort will be delighted to help you find an assembly partner who will assemble your purchase professionally. You can find more information on installation and the recommended prices at:

[www.biohort.com/assembly-service](http://www.biohort.com/assembly-service)

## Assembly Videos

To help with the assembly, we have created short assembly videos for many of our products. You can find them on our YouTube channel:

[www.youtube.com/biohort](http://www.youtube.com/biohort)

## Foundation Solutions

The foundation solutions SmartBase and SmartBase-<sup>PLUS</sup> form a stable foundation for Biohort garden sheds, the equipment locker and MiniGarage. The foundations are storm-proof and quick to install. More information on pages 30–33 and at:

[www.biohort.com/foundation](http://www.biohort.com/foundation)



## Product Configurator

The Biohort 3D-Configurator visualises within a few clicks each product including the individually desired accessories and even calculates the final price. Not enough: the handy augmented reality function allows you to virtually position the product directly in your garden via smartphone or tablet.

[www.biohort.com/configurator](http://www.biohort.com/configurator)

# This means Biohort Quality, Made in Austria.

## Durability

- 20 year guarantee, see page 09 for details.
- Hot-dipped galvanized and polyamide coated steel sheet
- High-quality fasteners and hinges (e.g. made of stainless steel)
- Lifetime maintenance free
- Rainwater proof

## Stability

- Double the plate thickness compared to low-cost providers
- Optimal structural design
- Storm proof up to 150 km/h, wind force 12\*
- High snow load of up to 150 kg/m<sup>2</sup>\*

## Functionality

- Extensive range of standard features
- Large selection of accessories
- Wide range of applications

## Security

- Locking mechanism with a cylinder lock
- Non-combustible metal construction

\*Only applies to garden sheds when professionally assembled and anchored.



## A company, that stands for exceptional quality.

Thirty years ago, the Austrian family-owned company began with a clear vision: Manufacturing high-quality outdoor products made of metal – for functional and stylish outdoor spaces and for people who value quality. Backed by three decades of experience, technical expertise, and a spirit of innovation, this has led to the creation of a diverse product portfolio. Today, we offer premium products in the areas of storage, gardening, and outdoor living – and are among Europe's leading providers. Your expectations drive us. Responsibility, reliability and the pursuit of quality shape our daily actions.

**"Quality is created when technical expertise meets responsibility and passion."  
– Julian Koller**

# Advantages of Metal

- No painting
- The high-quality steel used by Biohort does not deform and remains in shape for decades.
- The hot-dip galvanised, polyamide enamel coated steel used by Biohort is “fireproof” in accordance with EN 13501-1 (Class A1).
- German premium car manufacturers rely on the same steel sheet as we do.

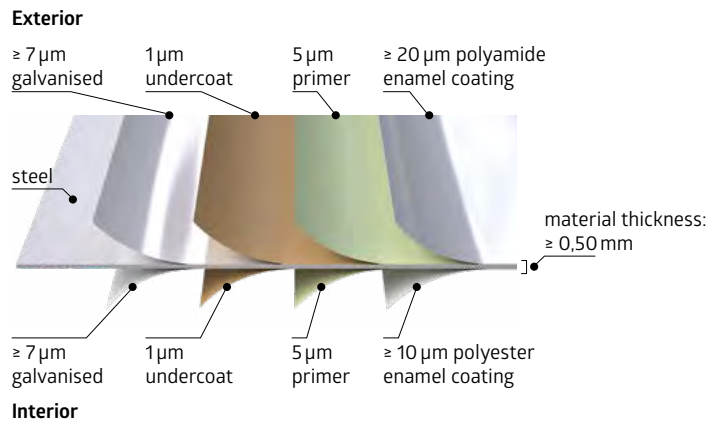

## Did you know?

### Stability Test

A scientifically supervised wind tunnel test at the Vienna University of Technology certifies that Biohort garden sheds, when properly assembled and anchored, can withstand wind loads of up to **150 km/h (wind force 12)**. Optimally designed profiles and the use of stainless steel screws further contribute to the durability of our products.

### Material

Biohort uses **hot-dip galvanized steel sheet** with an additional **polyamide-baked coating** for its products. The use of top-quality materials ensures that Biohort can confidently offer a **20 year guarantee** against corrosion. The prerequisite for this is that no aggressive substances (e.g. chlorine, salt, etc.) are stored and that there are no aggressive environmental conditions such as proximity to the sea or exposure to road salt.

### Biohort Colours

The colour coatings we use are produced exclusively for Biohort and do not match the **RAL numbers**. Since many Biohort dealers have show models or original colour samples, we recommend visiting them before your purchase. You can also request free material samples (colour sample sheets) on our website at [www.biohort.com/request-material-samples](http://www.biohort.com/request-material-samples)



The General Terms and Conditions (GTC) of Biohort GmbH apply. You can find these at: [www.biohort.com/gt&c](http://www.biohort.com/gt&c)  
Our terms of guarantee are available here: [www.biohort.com/terms-of-guarantee](http://www.biohort.com/terms-of-guarantee)





## Biohort

For better organization, for outdoors.



12 Europa



14 AvantGarde® and AvantGarde® ECO



16 HighLine®



18 Panorama®



20 Neo



22 CasaNova®



Europa size 3, metallic quartz grey  
(with aluminium floor frame and aluminium floor panels as accessories)

# Europa

## Quality at a Reasonable Price

### Everything Well Organised with the Biohort Classic

The Europa garden shed has been tried and tested for decades and is still very popular. Its high stability and durable materials make it an excellent choice. The functional features simplifies your gardening work and establishes order in your garden. An extensive range of standard features and sophisticated accessories fulfil your needs.



1 Europa size 4, metallic quartz grey with side canopy  
(see accessories p. 26)

1



## Advantages

### Security:

- Dual locking mechanism with T-handle cylinder lock
- Storm proof up to 150 km/h, wind force 12
- High snow load of up to 150 kg/m<sup>2</sup>

### Functionality:

- Integrated gutter with a connection for a 1" hose

### Standard Features:

- Double door
- Integrated organiser system on the inside of the doors (incl. 6 hooks)
- Tool hanger (4 pcs.)
- Shelves and support rails (2 pcs. each)
- Two additional mounting brackets for wall mounting (by size 2A and size 4A)
- Door hooks to secure the opened door panels



Metallic Silver



Metallic Quartz Grey



Metallic Dark Grey



Dark Green

## Optional Accessories

can be found on pages 24–33.

## Sizes (in cm, exterior dimensions incl. roof overhang)

### Door opening:

Double door: 135 x 170 cm (W x H) – from size 2A an off-centre installation of the double door possible, for sizes 2, 3, 4, 5, 6 and 7 side installation of the double door possible.

The dashed lines indicate the roof overhang.

Green bars mark the rain gutters and highlight where an optional side or front canopy can be added.

See page 26 for details.

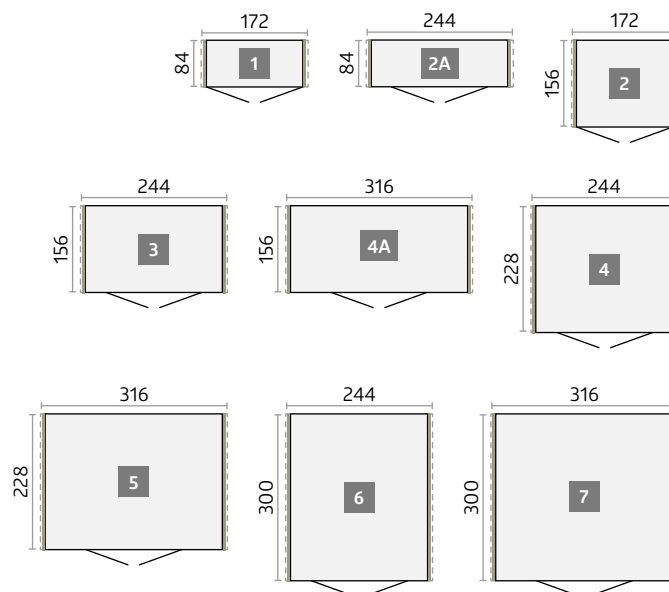

Technical data and detailed information can be found on pages 106–112.



AvantGarde® size A2, metallic silver  
(with smooth double door, window unit, aluminium floor frame and aluminium floor panels as accessories)

# AvantGarde®

## For Modern Architecture

### Top Quality Pent Garden Shed

The AvantGarde® metal shed lives up to its name in every respect. It impresses with an attractive design that meets the requirements of modern architecture. With its numerous practical advantages for everyday use, it guarantees lasting satisfaction. It is maintenance-free for life and therefore saves money and valuable spare time.



1 AvantGarde® size A3, metallic dark grey with side canopy including back and side wall  
(see accessories p. 26)



reddot design award

## Advantages

### Security:

- Triple locking mechanism with stainless steel door handle / dual locking mechanism in the ECO variant
- Storm proof up to 150 km/h, wind force 12
- High snow load of up to 150 kg/m<sup>2</sup>

### Functionality:

- Integrated gutter with a connection for a 1 1/4" hose
- Acrylic glass skylight with roof overhang

### Standard Features\*:

- Tool holder (2 pcs.)
- Tool hanger (4 pcs.)
- Shelves and support rails (2 pcs. each)
- Gas spring assisted door

\*not included in the ECO variant



Metallic Silver



Metallic Quartz Grey



Metallic Dark Grey

## Optional Accessories

can be found on pages 24–33.



Size A5 in the ECO variant, metallic quartz grey with corrugated standard door

## AvantGarde®ECO

For particularly price-conscious buyers, we recommend the ECO variant with corrugated door and T-handle cylinder lock. With integrated organiser system on the inside of the door and door hooks instead of the gas spring. **The ECO variant is supplied without the basic equipment, which makes it so attractive in price.** Door opening and sizes, just like the AvantGarde®. Also available with corrugated double door.

## Sizes AvantGarde® and AvantGarde®ECO

(in cm, exterior dimensions incl. roof overhang)

### Door opening:

Standard door (right door hinge):  
76 x 182 cm (W x H)

Double door A1–A4: 139 x 182 cm (W x H)

Double door A5–A8: 155 x 182 cm (W x H)

Further door installation variants by AvantGarde®:

Standard door with left-hand hinge.

For details see p. 112.

The dashed lines indicate the roof overhang. The green bars indicate the possible attachment side for an optional side or front canopy.  
For details see p. 26.

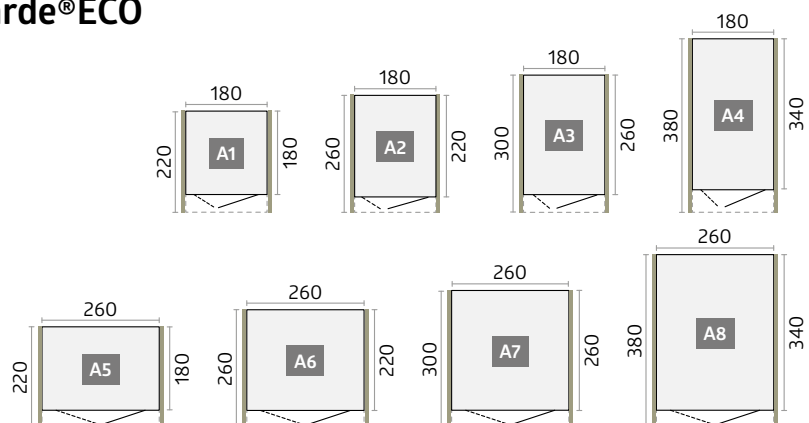

Technical data and detailed information can be found on pages 106–112.



HighLine® size H2, metallic dark grey  
(with aluminium floor frame, aluminium floor panels, door baskets, FloraBoard and double door as accessories)

# HighLine®

## Flat Roof Aesthetics for Your Storage Space

### The HighLine® Garden Shed Fulfils the Highest Standards

The HighLine® impresses with its elegant design and modern flat roof. The integrated all-round skylight sets strong accents and the timeless design fits into any setting. The HighLine® garden shed stands for durability and quality!



1 HighLine® size H3, metallic silver with side canopy:

Side and back walls as privacy screens are available separately (see accessories, p. 26).



## Advantages

### Security:

- Triple locking mechanism with stainless steel door handle
- Storm proof up to 150 km/h, wind force 12
- High snow load of up to 150 kg/m<sup>2</sup>

### Functionality:

- Integrated gutter with a connection for a 1 1/4" hose
- Gutter with integrated leaf traps fitted to both sides
- Gas spring assisted door

### Standard Features:

- Continuous acrylic skylight
- Tool holder (2 pcs.)
- Tool hanger (4 pcs.)
- Shelves and support rails (2 pcs. each)



Metallic Silver



Metallic Quartz Grey



Metallic Dark Grey

(Roof surface is always in metallic quartz grey)

## Optional Accessories

can be found on pages 24–33.

## Sizes (in cm, exterior dimensions incl. roof overhang)

### Door opening:

Standard door (right door hinge):  
76 x 182 cm (W x H)

Double door: 155 x 182 cm (W x H)

Further door installation variants: Standard door with left-hand hinge or optional double door. For details see p. 112.

The dashed lines indicate the roof overhang.

The green bars indicate the rain gutters or show the possible attachment side (from size H2 onwards) for an optional side or front canopy.

See page 26 for details.

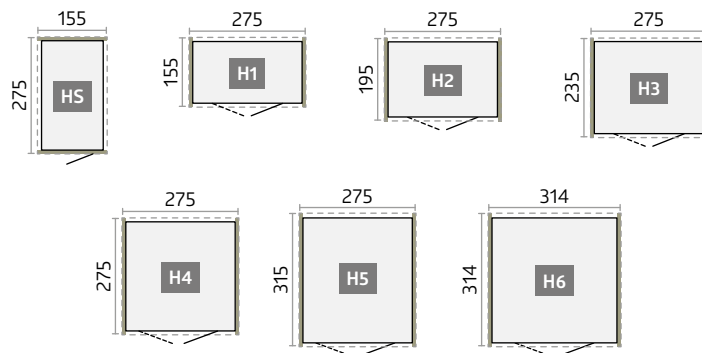

**Tip:** You can rotate the HighLine® from size H2 onwards to suit your own preferences, and the standard door can be installed in any side wall.

From size H4 onwards, the double door can also be installed on the side.

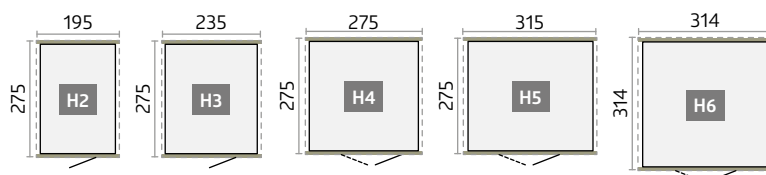

Technical data and detailed information can be found on pages 106–112.



Panorama® size P2, metallic dark grey  
(with aluminium floor frame and aluminium floor panels as accessories)

# Panorama®

## Interior Illumination

### The Beauty of Natural Light

The continuous skylight made of acrylic glass gives the Panorama garden shed a modern lightness, allowing this gable roof model to blend seamlessly into any garden setting. Proven Biohort quality in materials and workmanship, combined with customizable equipment options, makes the Panorama® model the perfect garden shed for those with high standards.



1 Panorama® P2, metallic quartz grey  
The standard door can be fitted in any side wall from size P2 onwards.



## Advantages

### Security:

- Triple locking mechanism with stainless steel door handle
- Storm proof up to 150 km/h, wind force 12
- High snow load of up to 150 kg/m<sup>2</sup>

### Functionality:

- Integrated gutter with a connection for a 1 1/4" hose
- Gutter with integrated leaf traps fitted to both sides
- Gas spring assisted door

### Standard Features:

- Continuous acrylic skylight
- Tool holder (2 pcs.)
- Tool hanger (4 pcs.)
- Shelves and support rails (2 pcs. each)



Metallic Silver



Metallic Quartz Grey



Metallic Dark Grey

## Optional Accessories

can be found on pages 24–33.

## Sizes (in cm, exterior dimensions incl. roof overhang)

### Door opening:

Standard door (right door hinge): 76 x 182 cm (W x H) – from size P2 onwards, the standard door can be installed in any side wall.

Double door: 155 x 182 cm (W x H) – from size P4 onwards, the double door can be installed in either side wall.

Further door installation variants: Standard door with left-hand hinge or optional double door. For details see p. 112.

The dashed lines indicate the roof overhang, and the green bars mark the rain gutters. See page 26 for details.

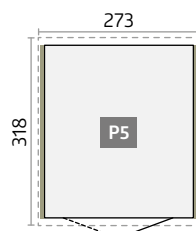
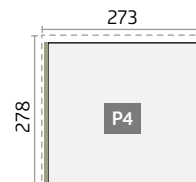
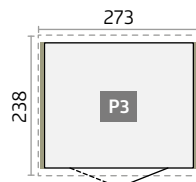
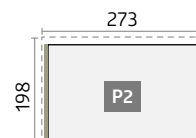
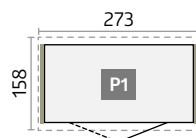

Technical data and detailed information can be found on pages 106–112.



Neo size 2B, metallic silver  
(with aluminium floor frame, aluminium floor panels and double door as accessories)

# Neo

## Revolution in Design & Functionality

### The Best From Decades of Experience – The Biohort Top Product

Smooth wall surfaces and the elegant acrylic glass panel in the door characterise the modern look. Additional glass panels can be flexibly installed thanks to a specially developed panel system. In addition to the wooden ceiling panel for regulating humidity, the optional white interior wall cladding and insulation contribute to a pleasant atmosphere.



1



2

- 1 Glass panel:**  
Thanks to a flexible panel system, glass panels can also be added.
- 2 Size 2B, metallic dark grey with side canopy:**  
Side and back walls as privacy screens are available separately (see accessories, p. 26).  
Tip: The glass panel and FloraBoard are also available for the side canopy.



## Advantages

### Security:

- Triple locking mechanism with stainless steel door handle
- Storm proof up to 150 km/h, wind force 12
- High snow load of up to 150 kg/m<sup>2</sup>
- Screw and rivet free surfaces

### Functionality:

- Gas spring assisted door
- Optional interior panelling and insulation
- Integrated roof gutter

### Standard Features:

- Tinted glass in the standard door
- Plywood ceiling with an EPDM roofing membrane
- Rainwater downpipe (2 pcs.)
- Tool holder (2 pcs.)
- Tool hanger (2 pcs.)
- Shelves (2 pcs.)



Metallic Silver



Metallic Quartz Grey



Metallic Dark Grey

## Optional Accessories

can be found on pages 24–33.

## Sizes (in cm, exterior dimensions incl. roof overhang)

### Door opening:

Standard door (right door hinge): 83 x 200 cm (W x H) – the standard door can be installed on the sides of the shed.

Double door: 167 x 200 cm (W x H) – the double door can be installed on the sides of the shed from 236 cm.

The green bars indicate the possible attachment side (from size 2A onwards) for an optional side canopy. For details see p. 26.

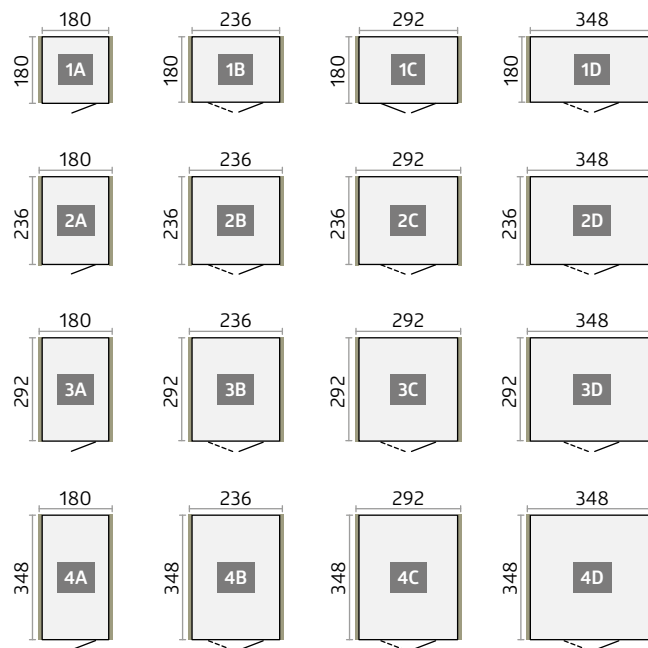

Technical data and detailed information can be found on pages 106–112.



CasaNova® 3 x 4, metallic dark grey (with aluminium floor frame, aluminium floor panels, external lighting and two glass elements as accessories)

# CasaNova®

## Design, Customised to Your Requirements

### The High End Metal Building with Insulated Side Walls

Whether as a garden shed, workshop or hobby room – the CasaNova® insulated design outbuilding demonstrates unique flexibility with a wide range of configuration options and adapts exactly to your requirements. Whether you're looking for functional storage space or want to create a utility area outdoors – the CasaNova® designer garden shed makes your wishes come true with exceptional quality.

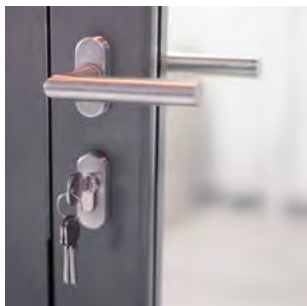

#### Insulated side walls / door panel

Sandwich element with 40 mm polystyrene core (EPS W20)

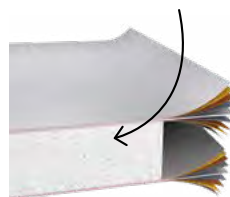



### Advantages

- Sandwich element with 40 mm core made of polystyrene (EPS W20)
- Screw and rivet free surfaces

### Security:

- Locking mechanism with stainless steel door handle
- Roof or snow load of up to 215kg/m<sup>2</sup> (minus any additional roof weight such as greenery)

### Functionality:

- Easy to heat thanks to thermal insulation; U-value of side walls: 0.76 W/(m<sup>2</sup>K)
- Door hinge position on the left or right available
- Large selection of accessories
- Ventilation via acrylic glass panel which can be opened
- Gas spring assisted door



Metallic Quartz Grey



Metallic Dark Grey

Configure your CasaNova® now!  
[www.biohort.com/configurator](http://www.biohort.com/configurator)

A separate product folder is available at  
[www.biohort.com/casanova-folder](http://www.biohort.com/casanova-folder) or from your Biohort dealer.

### Sizes (in cm, exterior dimensions incl. roof overhang)

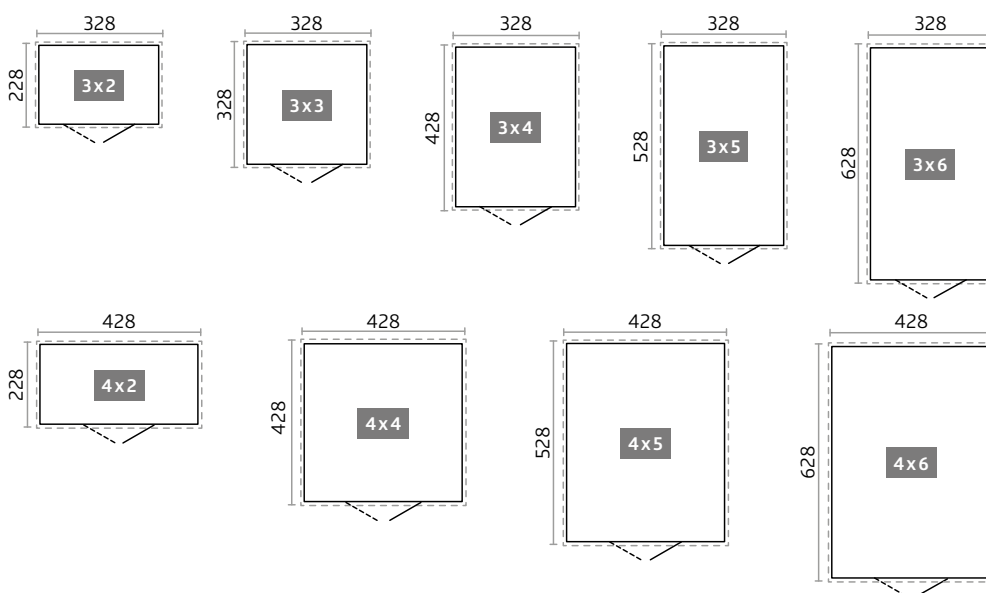

Technical data and detailed information can be found at [www.biohort.com/casanova](http://www.biohort.com/casanova)

\*Please note country-specific delivery conditions for large products.

## ✔ Standard Features

## ★ Optional Accessories

		Europa	AvantGarde®	AvantGarde®ECO	HighLine®	Panorama®	Neo**	Equipment Locker
01	<b>Shelf Support Rails</b> For mounting accessories such as shelves, shelf baskets, hook set, suspension basket and folding table. Standard Features: 2 support rails. (exception Neo garden shed: no support rails are required here, AvantGarde®ECO garden shed: no basic equipment)	✔ ★	✔ ★	★	✔ ★	✔ ★		✔ ★
02	<b>Shelves</b> Shelves with a depth of 24.5 cm or 43.5 cm are suspended in 2 support rails*. (2 pieces per package). (exception Neo garden shed: shelves of 26 cm or 44.5 cm depth.) Load capacity: 15 kg per shelf. <b>Standard features: 2 shelves</b> (exception AvantGarde®ECO garden shed: no basic equipment)	✔ ★	✔ ★	★	✔ ★	✔ ★	✔ ★	✔ ★
03	<b>Tool Hangers</b> To hang up spades, rakes, garden hoses and other garden tools. (Load capacity: 10 kg). <b>Standard features: 4 tool hangers</b> (exception Neo garden shed: 2 pieces, AvantGarde®ECO garden shed: no basic equipment)	✔ ★	✔ ★	★	✔ ★	✔ ★	✔ ★	✔ ★
04	<b>Tool Holder</b> For mounting on the interior of the door. A maximum of 4 tool holders can be fitted to the door panel. <b>Standard features: 2 tool holders</b> (exception AvantGarde®ECO garden shed: no basic equipment)		✔ ★	★	✔ ★	✔ ★	✔ ★	
05	<b>Solar Light</b> Thanks to its integrated battery, solar panel, and magnetic mount, the light can be easily and flexibly attached to the exterior wall of any garden shed or locker.	★	★	★	★	★	★	★
06	<b>LED Light</b> Battery-powered light with motion sensor and permanent light switch; magnetic fixation possible; including USB charging cable.	★	★	★	★	★	★	★
07	<b>Door Baskets</b> The door baskets can be easily fixed onto the inside of the door. Ideal for keeping garden tools, gloves, and more within easy reach. (Pack of 2). Size (W x L x H): 37 x 10 x 9.5 cm, load capacity: 1 kg per door basket	★	★	★	★	★	★	★
08	<b>Shelf Baskets</b> Shelf baskets are suspended in 2 support rails*. Ideal for storing grass seeds, tins and tools. (2 pieces per package). Size (W x L x H): 72 x 16 x 11 cm, load capacity: 3 kg per shelf basket	★	★	★	★	★	★	★
09	<b>Hook Set</b> Consists of a combination hook, a handle hook and a shovel hook on a wall rack that is hung between 2 support rails*.	★	★	★	★	★	★	★
10	<b>Suspension Basket</b> Ideal for storing small objects, includes wall bracket for hanging between 2 support rails*. Sack made of black polyester mesh. Size (W x L x H): 67 x 34 x 20 cm. (exception Neo garden shed: 55 x 34 x 20 cm).	★	★	★	★	★	★	★
11	<b>Bin Bag Holder</b> The bin bag holder enables neat and discreet storage – ideal for collecting deposit bottles or cans. The bin bag is simply hooked in and remains securely in place. The bracket can be mounted either in Biohort products or directly on the wall.	★	★	★	★	★	★	★
12	<b>Folding Table</b> The space-saving folding table is hooked into 2 support rails*. It quickly provides you with a stable work surface. Load capacity max. 30 kg, size (W x L): 69 x 58 cm.	★	★	★	★	★		★
13	<b>Electric Mounting Panel</b> Discreet, hidden cable routing and easy assembly of switches and outlets (electrical equipment in photo not included).	★	★	★	★	★	★	★
14	<b>Rainwater Downpipe Set</b> Two downpipes with outlet elbows in the same colour as the shed.	★	★	★	★	★	✔	
15	<b>Interior Panelling</b> Grey white interior wall panels are simply hooked into the side walls and screwed in place.						★	
16	<b>Insulation</b> The interior wall panelling can also be fitted with 40 mm thick insulation (styrofoam boards), which opens up many new possibilities for the garden shed.						★	

\*Support rails not included in the delivery (exception Neo garden shed: no shelf support rails are needed).

\*\*Attention: Neo garden shed does not have any corrugations like the other garden sheds, this has not been taken into account in the illustration.



01 Shelf Support Rails  
02 Shelves



03 Tool Hangers



05 Solar Light

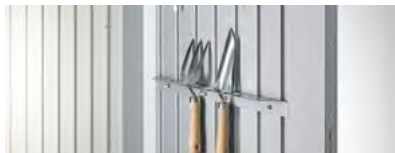

04 Tool Holder



06 LED Light



07 Door Baskets



09 Hook Set

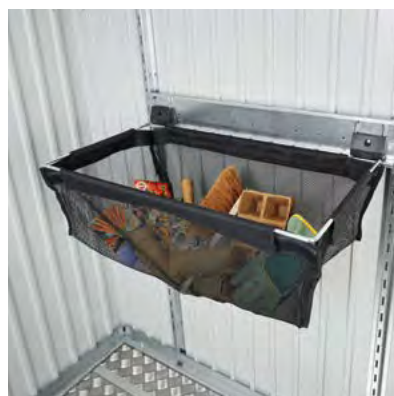

10 Suspension Basket



08 Shelf Baskets



11 Bin Bag Holder



12 Folding Table



13 Electric Mounting Panel



14 Rainwater Downpipe set

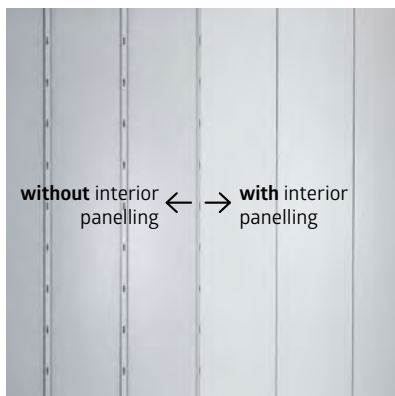

15 Interior Panelling for Neo Garden Shed



16 Insulation for Neo Garden Shed (unseen)

Technical data and detailed information can be found on pages 106–113.

## ✔ Standard Features

## ★ Optional Accessories

		Europa	AvantGarde®	AvantGarde®ECO	HighLine®	Panorama®	Neo**	Equipment Locker
17	<p><b>FloraBoard</b></p> <p>Two rails of the same colour as the shed are attached to the outer wall and the flower boxes can be hung on these at a suitable height. Plastic inserts for easier planting are included in the standard delivery scope.</p> <p><b>Tip:</b> For the Neo garden shed, the FloraBoard is also available for the side canopy's side or back walls.</p>		★	★	★	★	★	
18	<p><b>Gas Spring Set</b></p> <p>Provides a comfortable door opening. Scope of delivery: 2 pieces.</p>	★	✔	★	✔	✔	✔	★
19	<p><b>Window Unit</b></p> <p>The side wall panel with its metal-frame hinged window (plexiglass) brings even more daylight into the garden shed and provides a clear view of the garden (window opening: 50 x 60 cm).</p>	★	★	★	★	★		
20	<p><b>Glass Panel</b></p> <p>The tinted glass panel is enclosed in a metal frame (Dimensions: 28 x 207 cm) and can be flexibly installed in any side wall, but not next to a door, a corner element or another glass panel.</p> <p><b>Tip:</b> The glass panel is also available for the side canopy with side or back wall.</p>						★	
21	<p><b>PV Mounting Preparation for Side Wall</b></p> <p>Mounting option for PV modules – without drilling and therefore without loss of warranty. The delivery includes vertical rails that allow PV modules and balcony power plants to be mounted easily and securely using standard fastening materials. The shed thus becomes a green energy source.</p>	★	★	★	★	★	★	
22	<p><b>Double Door</b></p> <p>Makes entering and leaving the shed with large tools and equipment easier. The double door panel is equipped on the inside with a rotary lock and with a gas spring (exception: AvantGarde®ECO garden shed, Europa and equipment locker). Neo Garden Shed: standard with glass panel in the right-hand door panel. Exception equipment locker size 90: no double door possible.</p> <p>An additional double door is available as a further door installation variant. For details see p. 112. (Exception: AvantGarde® garden shed)</p>	✔	★	★	★	★	★	✔
23	<p><b>Additional Door</b></p> <p>Included in the delivery scope are a stainless steel door handle with standard cylinder (3-way locking mechanism), a gas spring, hinges, two tool holders and the appropriate door frame panels. The door can be hinged* on the right and on request also on the left. For details see p. 112. Neo garden shed: standard with tinted glass panel.</p> <p>AvantGarde®ECO garden shed: Also available in the cost-effective ECO version: door with corrugated surface, T-handle cylinder lock (dual locking), door hook, hinges, and an organization system on the inside of the door.</p> <p>Europa garden shed: double door with corrugated surface, T-handle cylinder lock (dual locking mechanism), door hooks, hinges and organiser system on the inside of the door.</p>		★		★	★	★	
24	<p><b>Side Canopy</b></p> <p>The side canopy can be attached to one or both sides of the Neo garden shed (from size 2A). The width of the side canopy is 300 cm. The aluminium supports are equipped with height-adjustable feet. Two rainwater downpipes are included.</p> <p>The side canopy is fixed to the HighLine® shed (from size H2) on the side with the rain gutter (optionally on one or both sides). It is available in two different sizes. The width of the side canopy size S is 150 cm and for size L 282 cm. The aluminium supports are equipped with height-adjustable feet. The rainwater downpipe is included.</p> <p>The side canopy for the Europa garden shed can be attached on the left, right or both sides. The set includes the supports, a short rainwater downpipe and the fixation material (not available for size 1 and size 2A).</p> <p>The side canopy for the AvantGarde® and AvantGarde®ECO garden sheds can be optionally mounted on the left, right, or both sides. The aluminium supports are equipped with height-adjustable feet. The delivery for sizes A4/A8 includes three support posts. Two rainwater downpipes are included. Only suitable for models manufactured in 2020 or later. For older models, please contact our customer service team.</p>	★					★	
25	<p><b>Side and Back Wall for Side Canopy</b></p> <p>Depending on preference, a back wall and/or a side wall can be added to the side canopy of the HighLine® garden shed (from size H2), Neo (from size 2A), and AvantGarde® / AvantGarde®ECO. They are available in the same colours as the shed.</p>		★	★	★		★	

\*Exception Neo garden shed: Here the door hinge is only possible on the right.



17 FloraBoard



19 Window Unit



20 Glass Panel for Neo Garden Shed



18 Gas Spring Set

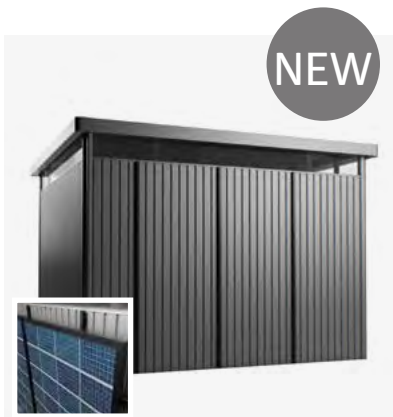

21 PV Mounting Preparation for Side Wall



22 Double Door / 23 Additional Door



24 Side Canopy for Neo Garden Shed



24 Side Canopy for HighLine® / Europa / AvantGarde® / AvantGarde®ECO Garden Shed



25 Side and Back Wall for HighLine® Side Canopy



25 Side and Back Wall for Side Canopy of the Neo / AvantGarde® / AvantGarde®ECO Garden Shed

Technical data and detailed information can be found on pages 106–113.



For more information:  
[biohort.com/bikelift](http://biohort.com/bikelift)



# biohort BikeLift<sup>®</sup> ↑



## The BikeLift<sup>®</sup> Advantages

-  Lift function for bikes weighing up to 30 kg
-  Suitable for tyre widths of up to 77 mm/ 3 inch

The Biohort BikeLift<sup>®</sup> can be mounted on the wall in the cellar, in the garage or carport in just a few easy steps. It is even easier to install in a Biohort shed – the BikeLift<sup>®</sup> is simply hooked in there with an additional module as an optional accessory.

The innovative lift is available in two variants: standard or swivel mounter.

## Comfortable lift function for every bike

From e-mountain bike to racing bike – the Biohort BikeLift<sup>®</sup> pulls any bike vertically up the wall as if by itself. This saves space and is effortless.



### Hook in

Simply hook the front wheel into the BikeLift<sup>®</sup>. The hook fits all tyre widths up to 77 mm.

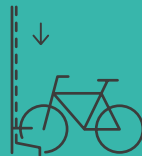

### Push

A short downward push on the handlebars is enough to activate the automatic lift function.



### Lift

Thanks to powerful spring tension, the BikeLift<sup>®</sup> lifts any bicycle (up to 30 kg) effortlessly – completely without electricity!



### Save space

Securely fixed and lockable, the bike hangs vertically on the wall to save space.

Technical data and detailed information can be found at [www.biohort.com/bikelift](http://www.biohort.com/bikelift).

## ★ Optional Accessories

		Europa	AvantGarde®	AvantGarde®ECO	HighLine®	Panorama®	Neo**	Equipment Locker
26	<p><b>BikeLift® Standard</b></p> <p>The mechanical bicycle lift is simply hooked into the wall profiles and is suitable for bicycles with an outer tyre diameter of up to 29 inches, a tyre width of max. 77 mm, a total height of the rim incl. tyre of max. 77 mm, a maximum bicycle length of 1.95 m and a maximum weight of 30 kg. The end of the rear mudguard and the luggage carrier must not protrude beyond the tyre. Integrated locking eyelet for bicycle locks.</p>	★	★	★	★	★	★	
27	<p><b>BikeLift® with Swivel Mount</b></p> <p>For even more space saving, the bike can be folded to the side of the wall thanks to the device. In the Europa garden shed, the BikeLift® with swivel mount can only be mounted centrally on the back wall.</p>	★	★	★	★	★	★	
28	<p><b>Threshold Access Ramp</b></p> <p>For outside and inside, for convenient crossing of the threshold, only possible with aluminium floor frame and double door.</p> <p>Load bearing capacity of max. 200 kg, length: 135 cm (exception Neo garden shed: 163.5 cm).</p>	★	★	★	★	★	★	
29	<p><b>Bicycle Hanger BikeMax</b></p> <p>Europa garden shed: height-adjustable in 6 different positions, for bicycles up to 26 inches, with a tire thickness of max. 5 cm and a weight of max. 25 kg.</p> <p>Neo, HighLine®, Panorama®, AvantGarde® and AvantGarde®ECO garden sheds: height-adjustable in 8 different positions and suitable for bikes with up to 29" wheels. Integrated locking eyelet for bicycle locks.</p>	★	★	★	★	★	★	
30	<p><b>BikeHolder</b></p> <p>Optimal storage of bicycles thanks to the adjustable retaining clamps. The base plate is hooked into 2 support rails*. Quick and easy securing of the bicycle tyres for a maximum of 3 bicycles per BikeHolder.</p>	★	★	★	★	★	★	

\*Support rails not included in the delivery (exception Neo garden shed: no shelf support rails are needed.)

\*\*Attention: Neo garden shed does not have any corrugations like the other garden sheds, this has not been taken into account in the illustration.



26 BikeLift® Standard



27 BikeLift® with Swivel Mount



28 Threshold Access Ramp



29 Bicycle Hanger BikeMax

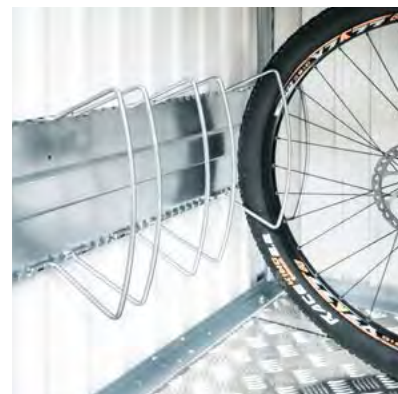

30 BikeHolder

Technical data and detailed information can be found on pages 106–116.



For more information:  
[www.biohort.com/foundation](http://www.biohort.com/foundation)

# Conventional Foundation Solutions\*



Rebated

## Concrete Foundation

A reinforced concrete foundation slab on a gravel base is an optimal, but also expensive foundation. With this type of foundation, you must also make sure that no water can penetrate into the shed at ground level. The offset foundation with a circumferential step of 2 cm x 7 cm is the ideal design for this (aluminium floor frame and aluminium floor panels cannot be used). As an alternative to the rebated concrete foundation slab surface, a continuous flat concrete slab can also be poured.

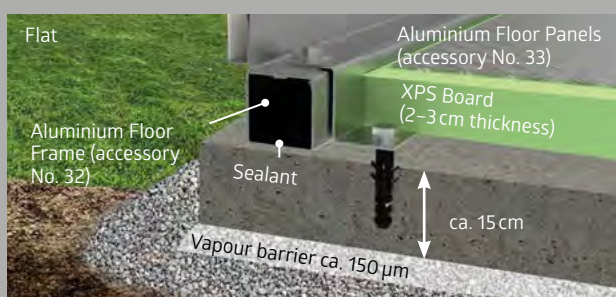

Flat

The available **aluminium floor frame** accessory makes it easier to level out any unevenness in the foundation and as well as fitting a sealing joint. The aluminium floor frame also allows the use of the **aluminium floor panels** which can be underlaid with XPS hard foam boards. (The XPS hard foam boards not included in the delivery).

## Point Foundation

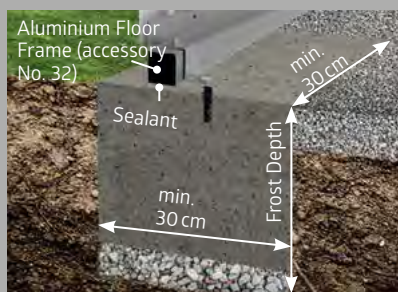

Another option for erecting garden sheds on uneven ground is a point foundation in conjunction with an **aluminium floor frame**.

## Paving Slabs

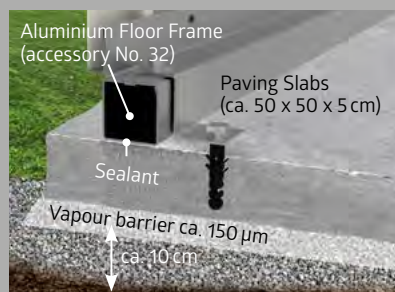

Paving slabs laid in a gravel bed offer a good and cost-effective solution. We strongly recommend the use of the **aluminium floor frame**.

## Floor Frame



With the **aluminium floor frame** you can also set up and anchor the shed on a gravel bed (ground anchors available as accessory). The **aluminium floor panels** (accessory) serve as a functional floor and are underlaid with XPS hard foam boards (XPS hard foam boards not included in the delivery).

\*non-binding recommendation for all garden sheds, the equipment locker and the MiniGarage.

# Biohort SmartBase Solutions

Detailed information on the SmartBase and SmartBase<sup>PLUS</sup> can be found on pages 32-33. —————>

## ★ Optional Accessories

		Europa	HighLine®	Panorama®	AvantGarde®	AvantGarde®ECO	Neo**	Equipment Locker
	<b>Aluminium Floor Frame</b> It gives the shed the necessary stability even without a concrete foundation.							
31	If the floor frame is laid directly on a gravel base (approx. 10 cm gravel, without foundation or slabs), ground anchors are required for securing to the ground. These are available as accessories – please refer to the technical data for the number of anchors. Storm resistance must be ensured by the customer for this foundation solution.	★	★	★	★	★	★	★
	<b>Aluminium Floor Panels</b> Depending on the size of the shed, the high-quality aluminium chequer plate floor consists of several segments including connecting profiles. To ensure the optimal fitting, the aluminium floor frame is necessary (see above). We recommend using a filler layer of loose material or XPS rigid foam panels with a thickness of approximately 2–3 cm (not included in the delivery).							
32		★	★	★	★	★	★	★
	<b>SmartBase</b> The perfect base for solid ground surfaces (concrete or paved areas). Light ground irregularities of up to 4 cm can be compensated. <b>See page 32 for details.</b>							
33		★	★	★	★	★	★	★
	<b>SmartBase<sup>PLUS</sup></b> Optimum solution for slopes and lawns, patented system with ground screws to compensate for slopes of up to 15 cm. <b>See page 33 for details.</b>							
34		★	★	★	★	★	★	★



31 Aluminium Floor Frame



33 SmartBase  
See details on next page.



32 Aluminium Floor Panels



34 SmartBase<sup>PLUS</sup>  
See details on next page.



Technical data and detailed information can be found on pages 106–113.



Rainwater barrier



Height adjustment with adjustable feet



Adjustable feet

# SmartBase

## Perfect Base for Hard Surfaces

The Biohort SmartBase Foundation is the ideal foundation for concrete or paved areas. It consists of high-quality aluminium boards, a special foundation frame and height-adjustable feet. So light ground irregularities of up to 4 cm can be compensated.

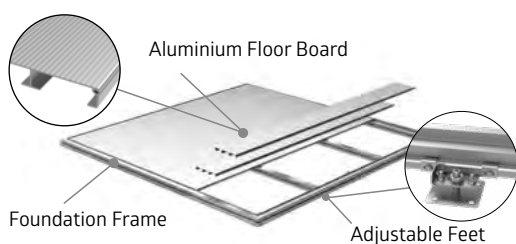

## Advantages

- Compensation of unevenness through adjustable feet
- Easy to remove if necessary
- Precisely fitted to all Biohort garden sheds, the Equipment Lockers and the MiniGarage
- Storm proof
- Load bearing capacity max. 200 kg/m<sup>2</sup>

### Standard Features:

- Aluminium floor boards with grooved surface
- Specially designed foundation frame
- Galvanised adjustable feet
- Adjustable feet with height adjustment
- Integrated water barrier to protect against water ingress

**Floor frame and floor panels are no longer necessary!**

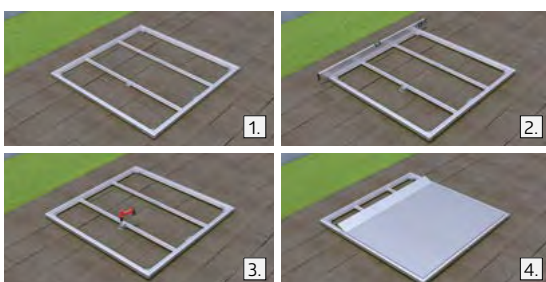

**Time of assembly:** 1–2 hours with two people (depending on craftsmanship and product). **Tools required:** spirit level, drill, open ended spanner SW13 and SW24.

1. Frame assembly
2. Connection of adjustable feet and frame alignment
3. Fixing the adjustable feet to the subsurface
4. Fixing of aluminium floor boards

**Technical data and detailed information** can be found on pages 106–113.



Rainwater barrier



Height adjustment with ground screws

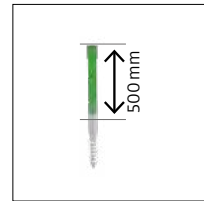

Optional: Extension kit for ground screws

# SmartBase<sup>PLUS</sup>

## Optimal Base for Slopes and Lawns

Unlike the SmartBase foundation, the patented SmartBase<sup>PLUS</sup> system includes ground screws instead of adjustable feet. These are screwed directly into the ground and can compensate for slopes of up to 15 cm (extensions for greater height differences available upon request). The ground should be compact and free of large stones.

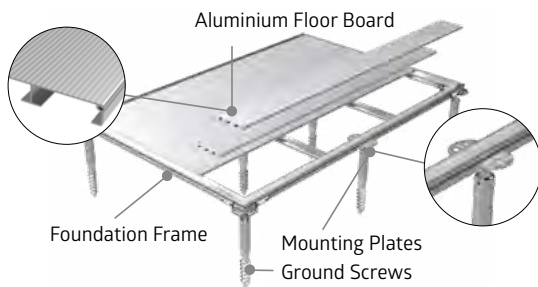

## Advantages

- Little excavation
- Gravel base is not necessary
- Compensation of unevenness through ground screws
- Easy to remove if necessary
- Precisely fitted to all Biohort garden sheds, the equipment lockers and the MiniGarage
- Storm proof
- Load bearing capacity max. 200 kg/m<sup>2</sup>

### Standard Features:

- Aluminium floor boards with grooved surface
- Specially designed foundation frame
- Galvanised ground screws
- Multi-adjustable mounting plates
- Including manual screw-in driver
- Integrated water barrier to protect against water ingress

**Floor frame and floor panels are no longer necessary!**

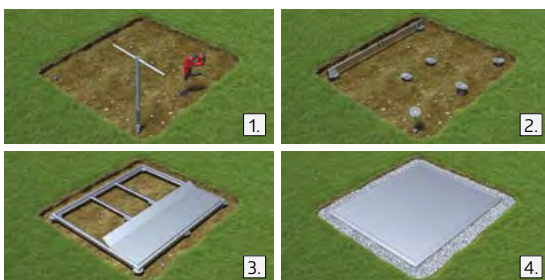

**Time of assembly:** 2-4 hours with two people (depending on craftsmanship and product). **Tools required:** hammer drill, drill bit Ø 40 x 570 mm, spirit level, drill, open-end spanner SW13 and SW24, shovel.

1. Site preparation and ground screw insertion
2. Attachment and levelling of mounting plates
3. Positioning and attachment of frame
4. Fixing of aluminium floor boards

Technical data and detailed information can be found on pages 106-113.





**36** Equipment Locker



**38** Romeo® Patio Locker



**40** Julia® Patio Locker



**42** WoodStock®



## Biohort

For better organization,  
for outdoors.



Equipment Locker size 190, metallic quartz grey  
(with door baskets, shelf baskets, aluminium floor frame, and aluminium floor panel as accessories)

# Equipment Locker

## Generous Storage Space for Garden Utensils

### Versatile Outdoor Locker for Outdoor Use

In the garden, on the terrace, in the garage or on the balcony it organises and stores your tools without restricting your living space. With the Biohort equipment locker you can store garden equipment, barbecue grills, garden furniture, and other similar items protected from rain and theft. It blends harmoniously into its location thanks to seven different sizes and its elegant design.

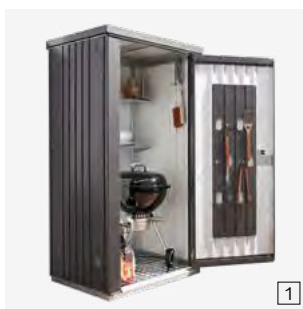

1 Size 90, metallic dark grey with aluminium floor frame and floor panels  
(see accessories p. 31)



## Advantages

### Security:

- Dual locking mechanism with T-handle cylinder lock
- Fireproof
- High snow load of up to 150 kg/m<sup>2</sup>
- Storm proof up to 150 km/h, wind force 12

### Functionality:

- Invisible, integrated ventilation

### Standard Features:

- Double door (from size 150)
- Integrated organiser system on the inside of the doors (incl. 6 hooks)
- Tool hanger (4 pcs.)
- Shelves and support rails (2 pcs. each)
- Door hooks to secure the opened door panels



Metallic Silver



Metallic Quartz Grey



Metallic Dark Grey

## Optional Accessories

can be found on pages 24–33.

## Sizes (in cm)

### Door opening:

Size 90: 65 x 170 cm (W x H),  
Size 150–230: 135 x 170 cm (W x H)

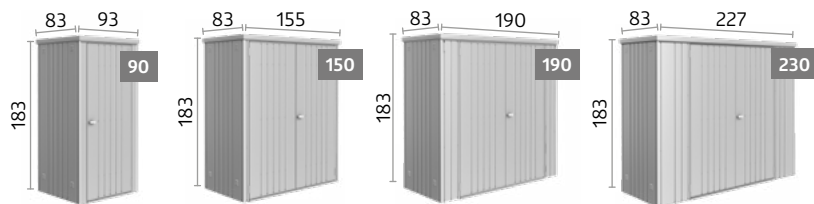

### Door opening:

135 x 170 cm (W x H)

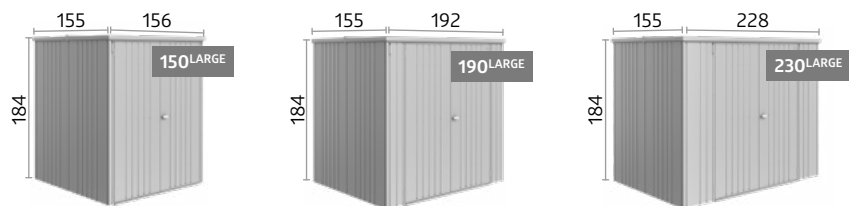

Technical data and detailed information can be found on page 113.



Patio Locker Romeo® size M, metallic quartz grey  
(with shelf as accessory)

# Romeo® Patio Locker

## Generous Storage Space for Balcony Utensils

### Spacious Patio Locker

The Romeo® patio locker offers practical storage space for the balcony and patio. The double door provides convenient access to your outdoor items. Standard features include a dual locking system, a gas spring for gentle closing, shelves, and an organization system on the inside of the door.





## Advantages

### Security:

- Double locking mechanism with T-handle cylinder lock
- Rainwater proof

### Functionality:

- Gas spring assisted door
- Invisible, integrated ventilation

### Standard Features:

- Shelves (2 pcs.) and support rails (3 pcs.)
- Organiser system fitted inside the door (incl. 6 hooks)



Metallic Silver



Metallic Quartz Grey



Metallic Dark Grey

## Sizes (in cm)

### Door opening:

Size M, size L: 103 x 131 cm (W x H)

Size M<sup>HIGH</sup>, size L<sup>HIGH</sup>: 103 x 171 cm (W x H)

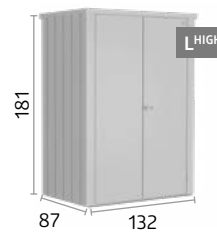
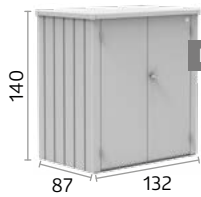
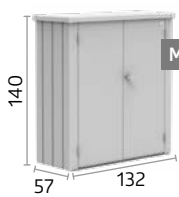

## ★ Optional Accessories



### Shelves (2 pcs.)

Galvanised steel shelves available in addition to the shelves which are part of the standard delivery scope.

Technical data and detailed information can be found on page 114.



Patio Locker Julia® size M<sup>HIGH</sup>, metallic dark grey  
(with shelf as accessory)

NEW

# Julia® Patio Locker

## Efficient Storage Space for Balcony Utensils

### Compact Patio Locker for Small Outdoor Spaces

Where there's a Romeo, there's also a Julia® – our patio lockers evolve with the demands of modern outdoor spaces. With four new sizes and its single door, the Julia® patio locker adapts to different space requirements and creates structured organisation on balconies and patios. Like Romeo®, Julia® also impresses with a dual locking system, gas springs for soft closing and shelves as standard.

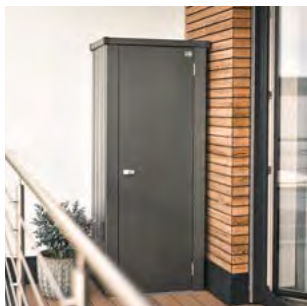



## Advantages

### Security:

- Dual locking mechanism with T-handle cylinder lock
- Rainwater proof

### Functionality:

- Comfortable door opening with gas spring
- Invisible, integrated ventilation

### Standard Features

- One shelf
- Organiser system fitted inside the door (incl. 4 hooks)



Metallic Silver



Metallic Quartz Grey



Metallic Dark Grey

## Sizes (in cm)

### Door opening:

Size M, size L: 51 x 131 cm (W x H) (right door hinge)

Size M<sup>HIGH</sup>, size L<sup>HIGH</sup>: 51 x 171 cm (W x H), (right door hinge)

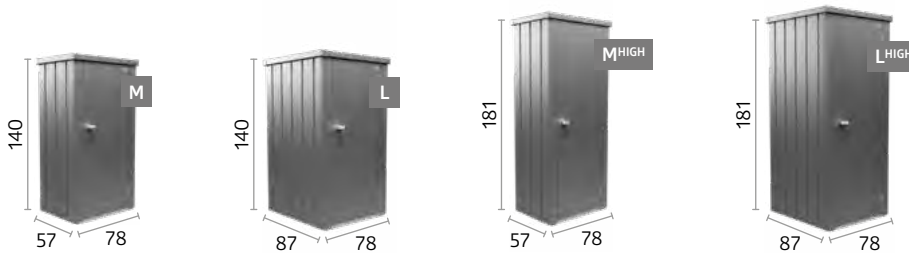

## Optional Accessories



### Full-sized Shelf (1 piece)

Galvanised shelf for full-surface storage.

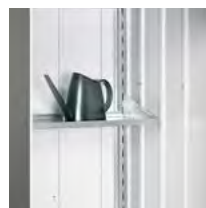

### Shelf Set (2 pcs.)

Galvanised steel shelves.

Technical data and detailed information can be found on page 114.



WoodStock® size 150, metallic quartz grey  
(with back wall, door kit, and aluminium floor panel as accessories)

# WoodStock®

## Protection for Wood, Tools and More

### Shelter for Dry and Secure Outdoor Storage

The WoodStock is a versatile storage solution for outdoor areas. It is suitable for dry storage of firewood – even in two rows. With an optional back wall and double door, it can also be used as a compact equipment locker. The integrated rain gutter at the front ensures controlled water drainage.



Integrated gutter on the front side.



### Advantages

- Stability because of massive aluminium frame
- Wide range of accessories available

### Security:

- Integrated gutter on the front side
- Universally applicable for garden tools
- Storm proof up to 150 km/h, wind force 12

### Functionality:

- Screws and anchors for fixation to the ground



Metallic Silver



Metallic Quartz Grey



Metallic Dark Grey

### Größen (in cm)

#### Volume:

Size 150: 2.1m<sup>3</sup>

Size 230: 3.1m<sup>3</sup>

Size 300: 4 m<sup>3</sup>

Firewood storage possible in two rows  
(maximum log length: 35 cm)

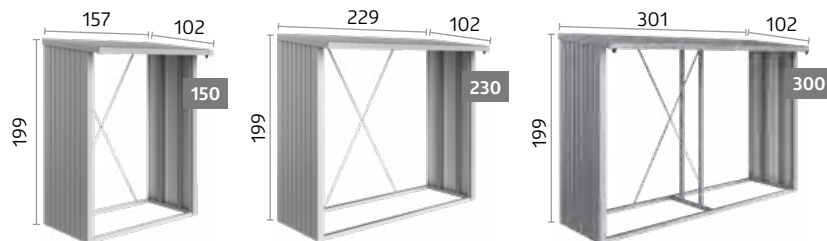

### Optional Accessories

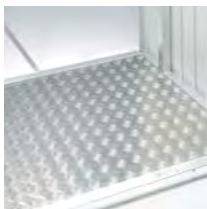

#### Aluminium Floor Panels

High quality aluminium chequer plate, protects the stored wood and gardening equipment from moisture.



#### Door Package

(suitable for size 150 & 230)

Double door fitted with T-handle cylinder lock and organiser system on the inside of the doors, Door opening: 135 x 171 cm (W x H).



#### Back Wall

Made from galvanised, polyamide coated steel.

Technical data and detailed information can be found on page 113.





## Biohort

For more  
storage space,  
for outdoors.



46 LeisureTime Box



48 StyleBox®



50 LoungeBox®



52 StoreMax®



54 HighBoard



LeisureTime Box size 130, metallic dark grey  
(with suspension basket and lid storage net as accessories)

# LeisureTime Box

## Stylish & Durable

### The Perfect Box for Outside

It stores all those items you cannot find a suitable storage place for. Ideal for stowing away seat cushions, toys, sun loungers, folding chairs, sports and camping equipment. 5 sizes, 5 colours for every demand. The perfect long-lasting solution through the use of high-quality materials.





## Advantages

### Security:

- Dual locking mechanism with T-handle cylinder lock
- Rainwater proof

### Functionality:

- Comfortable lid with gas spring
- Invisible, integrated ventilation



Metallic Silver



Metallic Quartz Grey



Metallic Dark Grey

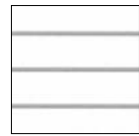

White



Metallic Bronze

## Sizes (in cm)

Tip: Also ideal as Parcel Box!

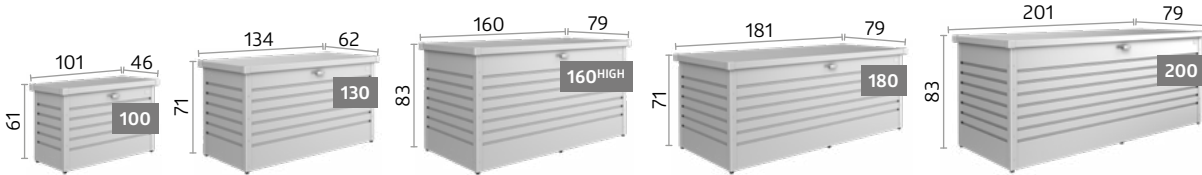

## Optional Accessories



### Suspension Basket

The sack made of black polyester mesh offers additional variable storage space and is simply hooked onto the frame.

Load capacity max. 10 kg.



### Parcel Box Kit

Stainless steel locking bar and padlock with number combination and stainless steel securing cable.



### Lid Storage Net

The solution for small parts can be easily attached to the inside of the lid.

Two nets can be fixed side by side in the LeisureTime Box 180.



Technical data and detailed information can be found on page 114.



StyleBox® size 170, metallic quartz grey  
(with suspension basket and lid storage net as accessories)

# StyleBox®

## For More Lifestyle

### Storage as a Design Element

With its sleek surfaces and flawless craftsmanship, the outdoor box presents itself as both high-quality and stylish. The innovative plug-in system allows for quick and easy assembly. Whether on the terrace, the balcony or in the garden – the design fits perfectly into any environment.





## Advantages

### Security:

- Lockable by means of cable padlock (lock not included)
- Rainwater proof

### Functionality:

- Comfortable lid with gas spring
- Practical snap lock
- Quick assembly thanks to innovative plug-in system
- Invisible, integrated ventilation

### Standard Features:

- Four height adjustable feet for levelling on uneven floors



Metallic Silver



Metallic Quartz Grey



Metallic Dark Grey

## Sizes (in cm)

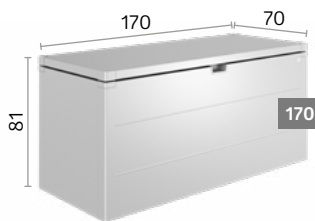
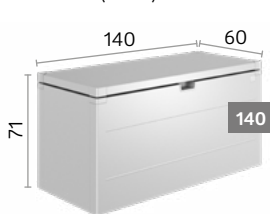

## ★ Optional Accessories



### Suspension Basket

The sack made of black polyester mesh offers additional variable storage space and is simply hooked onto the frame. Load capacity max. 10 kg.



### Castors

Two rubberised, rigid castors are mounted on one side to enable the box to be moved. 2 pieces per package.

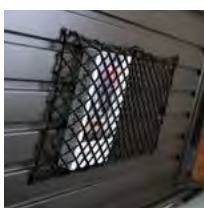

### Lid Storage Net

The solution for small objects. It can be easily attached to the inside of the lid.

Technical data and detailed information can be found on page 114.



# LoungeBox®

## Stylish Elegance

### Design for High Standards

The LoungeBox® provides weatherproof storage for seat cushions and covers. A turn knob cylinder lock reliably protects the contents. Thanks to the gas spring, the lid opens effortlessly and stays securely in the open position. Thanks to special hinges, the box can be placed directly against the wall. Smooth surfaces and concealed fasteners give the box a clean, modern look.



The elegant lid with its smooth look can also be opened easily when placed directly against a wall



### Advantages

- Lid made from aluminium
- Screw and rivet free surfaces

### Security:

- Locking mechanism with turn knob cylinder lock
- Rainwater proof

### Functionality:

- Comfortable lid with gas spring
- The elegant lid with its smooth look can also be opened easily when placed directly against a wall
- Invisible, integrated ventilation



Metallic Silver



Metallic Quartz Grey



Metallic Dark Grey

### Sizes (in cm)

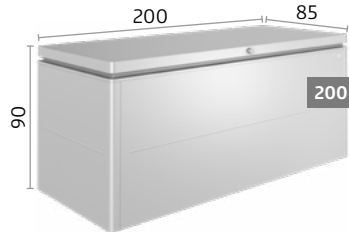
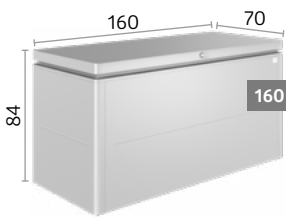

### Optional Accessories



#### Suspension Basket

The sack made of black polyester mesh offers additional variable storage space and is simply hooked onto the frame.

Load capacity max. 10 kg.



#### Lid Storage Net

The solution for small objects. It can be easily attached to the inside of the lid.

Technical data and detailed information can be found on page 114.



StoreMax® size 190, metallic silver

# StoreMax®

## Design Outside, Space Inside

### Organization at its Finest

A garden is a feel-good oasis – at least if it is tidy. This is why the StoreMax® offers maximum storage space in a small space, which can be individually divided up with shelves and shelving units. Whether as a lawn mower garage, garden tool box or storage space for pillows, behind the two-part opening system there is room for everything!



The top shutter can be opened separately.  
To fully open the StoreMax® the front shutter fully glides back.



## Advantages

- Shutter made from aluminium

### Security:

- Dual locking mechanism with T-handle cylinder lock
- Rainwater proof

### Functionality:

- Easy operation due to spring support

### Standard Features:

- Tool holder on the inside of the side wall



Metallic Silver



Metallic Quartz Grey



Metallic Dark Grey

## Sizes (in cm)

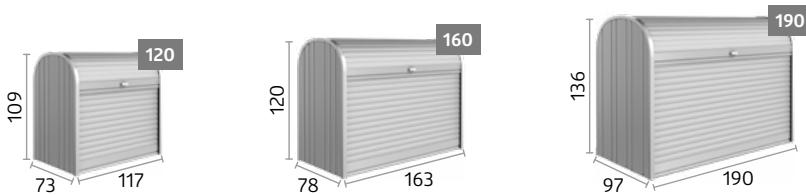

## ★ Optional Accessories



### Corner Shelf Set

(suitable for size 120 & 160)

2 shelves (triangular-shaped) with support rails, height adjustable in 5 different positions, easy to retrofit without any tools, can be fitted on the left or the right as required.



### Shelf Set

(suitable for size 190)

2 steel shelves (72 x 24,5cm) and 2 support rails.



### Intermediate Shelf

(suitable for size 160 & 190)

2-pieces, galvanised steel shelf with support rails, supports a load of ca. 100 kg; can also be used as a 2-piece shelf, height adjustable in 5 different positions, easy to retrofit.

Technical data and detailed information can be found on page 115.



HighBoard size 160, metallic quartz grey  
(with lid storage net and intermediate shelf as accessories)

# HighBoard

## Highlight on the Patio

### Multitalent for Storage

Thanks to the double doors and opening lid, the applications for the HighBoard are almost limitless: whether as a storage space for cushions and garden equipment or as the perfect extension to your outdoor kitchen, everything is protected from the weather and neatly stowed away. Its elegant design has been developed by industrial designers and is a guaranteed highlight on every patio.





## Advantages

- Screw and rivet free surfaces

### Security:

- Locking mechanism with turn knob cylinder lock
- Rainwater proof

### Functionality:

- Comfortable lid opening with gas spring
- The elegant lid with its smooth look can also be opened easily when placed directly against a wall
- Invisible, integrated ventilation

### Standard Features:

- Wheelie bin lid opener (3 pcs.)



Metallic Silver



Metallic Quartz Grey



Metallic Dark Grey

## Sizes (in cm)

### Door opening:

Size 160: 140 x 100 cm (W x H)  
Size 200: 167 x 110 cm (W x H)

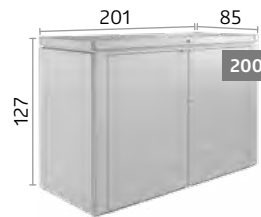
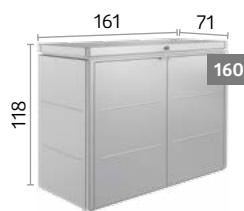

## ★ Optional Accessories



### Suspension Basket

The sack made of black polyester mesh offers additional variable storage space and is simply hooked onto the frame. Load capacity max. 10 kg.



### Tool Holder

For mounting on the inside of the doors. Max. 2 tool holders per door panel possible.



### Intermediate Shelf

In metallic silver, 9 position height adjustment. Easy to install and universally adaptable (e.g. as a continuous shelf or as 2 shelves). Load capacity max. 50 kg.



### Lid Storage Net

The solution for small objects. It can be easily attached to the inside of the lid.

Technical data and detailed information can be found on page 115.

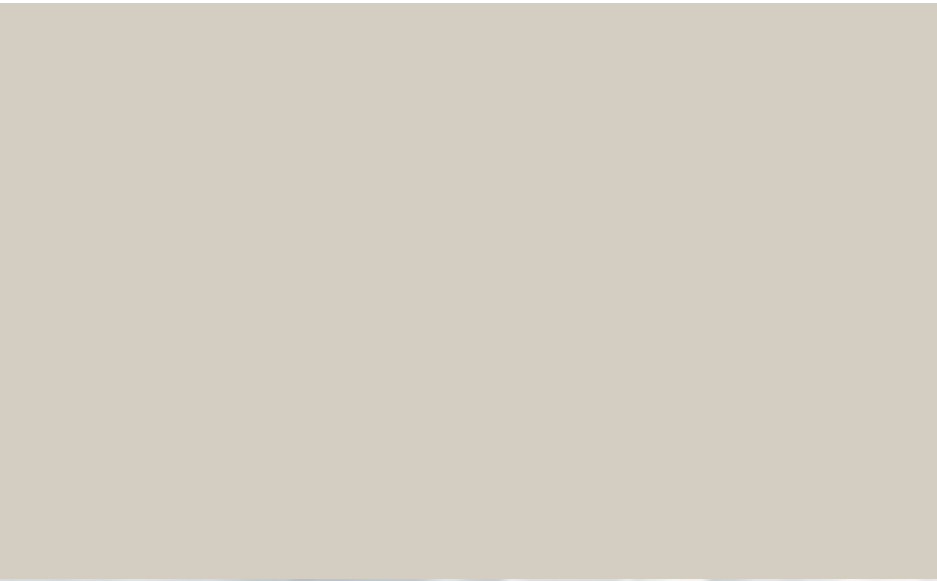



**Biohort**  
 For secure  
 storage, for  
 outdoors.



**58** MiniGarage



**60** StoreMax®



**62** HighBoard

**Tip:**

Biohort garden sheds also offer ample space to securely store bicycles. For details, see page 10.



MiniGarage size L, metallic silver  
(with shelf set, bike rail, aluminium floor frame and floor panels as accessories)

Now also available in metallic quartz grey.

# MiniGarage

## Small with Big Benefits

### Secure Bicycle Garage with Practical Details

The MiniGarage is ideal for storing up to two bicycles or garden tools and garden furniture etc. The intelligent rail system (optional) facilitates the storage of bicycles: Place the front wheel in the guide rail, push it to the back with the bicycle seat until the front wheel is in the clamp, done! The shelf set is ideal for storing additional bicycle accessories.



1 MiniGarage size L, metallic silver  
(with aluminium floor frame and aluminium floor panels as accessories)



## Advantages

### Security:

- Rainwater proof
- Locking mechanism with turn T-handle cylinder lock

### Functionality:

- Gas spring assisted door
- Invisible, integrated ventilation

### Standard Features:

- Organiser system fitted inside the door (incl. 6 hooks)



Metallic Silver



Metallic Quartz Grey



Metallic Dark Grey

## Size (in cm)

### Door opening:

125 x 137 cm (W x H)

### Interior dimensions:

140 x 195 x 143 cm (L x W x H)

### Storage capacity:

Holds 2 adult bicycles (please check your bicycle dimensions; more information available at [www.biohort.com](http://www.biohort.com))

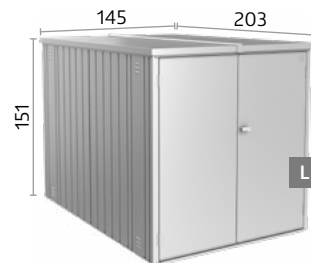

## ★ Optional Accessories



### Bike Rail

The clamp panel is mounted on the back wall. The guide rail is hooked in at the desired height and allows for easy extraction and storage of bikes.

Max. 2 bike rails possible. Max. Tyre width: 70 mm, max. bike length: 1.92 m.

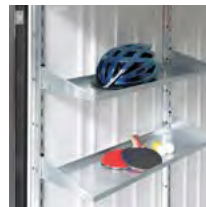

### Shelf Set

2 shelves (77 x 26,8 cm) and 2 support rails.



### Electric Mounting Panel

Discreet, hidden cable routing and easy assembly of switches and outlets (electrical equipment in photo not included).

Incl. 2 support rails.



### Foundation Solutions

Aluminium floor frame / aluminium floor panels

SmartBase / SmartBase<sup>PLUS</sup>

For details, see page 30-33.

Technical data and detailed information can be found on page 115.



StoreMax® size 190, metallic silver

# StoreMax®

## Roller Shutter Up, Bicycle Out

### Cuts Quite a Figure

Right in front of your home, immediately ready: the rainproof StoreMax® bicycle garage with the BikeHolder offers a maximum of storage without needing much space itself – perfect dimensions for up to two bicycles. The very smoothly working roller shutter helps you save your energy for the bicycle tour and protects your bicycle with a robust cylinder lock.

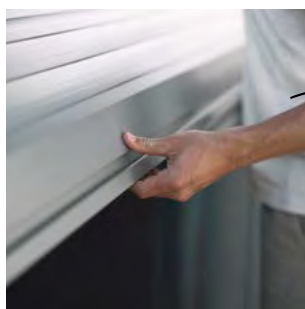

The top shutter can be opened separately.

To fully open the StoreMax® the front shutter fully glides back.



## Advantages

- Shutter made from aluminium

### Security:

- Dual locking mechanism with T-handle cylinder lock
- Rainwater proof

### Functionality:

- Easy operation due to spring support

### Standard Features:

- Tool holder on the inside of the side wall



Metallic Silver

Metallic  
Quartz GreyMetallic Dark  
Grey

## Size (in cm)

### Interior dimensions:

188 x 86 cm (W x H)

### Storage capacity:

Holds 2 adult bicycles (please check your bicycle dimensions; more information available at [www.biohort.com](http://www.biohort.com))

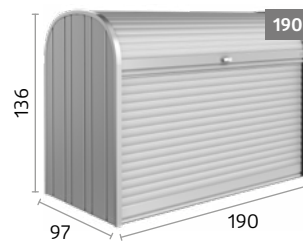

## ★ Optional Accessories



### BikeHolder Set

The base plate including adjustable clamping levers can be hooked into 2 shelf support rails and provides optimal storage for 2 bicycles.

Technical data and detailed information can be found on page 115.



HighBoard size 200, metallic silver  
(with BikeHolder and electric mounting panel as accessories)

# HighBoard

## A Roomy Home for Your Bicycle

### Store Your Valuables Safely

Cycling keeps you fit – and the HighBoard keeps your bike safe: fully protected from rain, with integrated ventilation, special bicycle holders, and a robust cylinder lock for theft protection. Up to two bicycles can be easily stowed and removed due to the lid which can be additionally opened. So nothing is standing in the way of a spontaneous cycling tour.

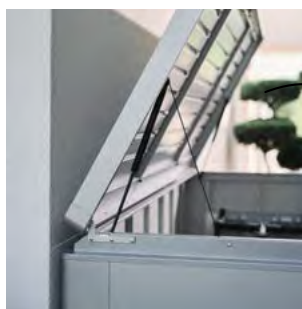
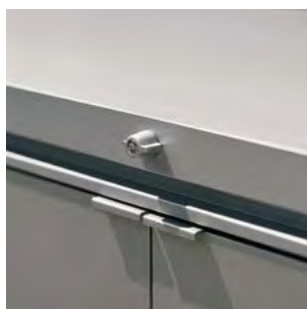

The elegant lid with its smooth look can also be opened easily when placed directly against a wall



## Advantages

- Screw and rivet free surfaces

### Security:

- Rainwater proof
- Dual locking mechanism with T-handle cylinder lock

### Functionality:

- Comfortable lid opening with gas spring
- The elegant lid with its smooth look can also be opened easily when placed directly against a wall
- Invisible, integrated ventilation

### Standard Features:

- Wheelie bin lid opener (3 pcs.)



Metallic Silver



Metallic Quartz Grey



Metallic Dark Grey

## Size (in cm)

### Door opening:

167 x 110 cm (W x H)

### Interior dimensions:

195 x 76 x 120 cm (L x W x H)

### Storage capacity:

Holds 2 adult bicycles (please check your bicycle dimensions; more information available at [www.biohort.com](http://www.biohort.com))

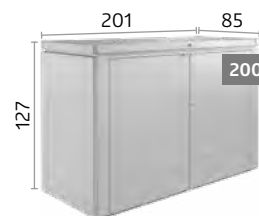

## ★ Optional Accessories



### BikeHolder

The base plate including adjustable clamping levers can be hooked onto the inside of the side wall and provides optimal storage for 2 bicycles.



### Electric Mounting Panel

Discreet, hidden cable routing and easy assembly of switches and outlets (electrical equipment in photo not included).



### Tool Holder

For mounting on the inside of the doors. Max. 2 tool holders per door panel possible.



### Lid Storage Net

The solution for small objects. It can be easily attached to the inside of the lid.

Technical data and detailed information can be found on page 115.





## Biohort

For more style,  
for outdoors.



66 Alex®



68 Alex® Duo



70 StoreMax®



72 HighBoard



Alex®, metallic quartz grey

# Alex®

## Modular Wheelie Bin Box

### Modern Design, Clever Details

With the Alex® bin system, any number of boxes can be lined up, making it ideal for organizing waste separation systems. The wheelie bin can be easily tipped out, the retaining bracket fixes it in the inclined position and facilitates filling. The modern design noticeably enhances your outdoor space.



Two combined Alex® wheelie bin boxes, metallic quartz grey



Function floor for wheel positioning



### Advantages

- Can be expanded as required due to modular design
- Integrated ventilation

### Security:

- Locking mechanism with turn knob cylinder lock
- Rainwater proof

### Standard Features:

- Catch bar for tipping out the wheelie bin
- Function floor for wheel positioning
- Organiser system fitted inside the door (incl. 3 hooks)



Metallic Silver



Metallic Quartz Grey



Metallic Dark Grey

### Size (in cm)

**Door opening:**  
65 x 118 cm (W x H)  
Available with left door hinge

**Storage capacity:**  
120 L wheelie bin or 240 L wheelie bin

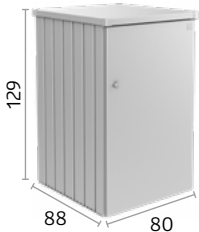

### ★ Optional Accessories



**Connecting Element**  
The connecting element covers the gap between two wheelie bin boxes at the front and back.



**Matching Cylinder Lock**  
If several boxes are used, access is possible with only one single key.



**Shelves / Supports Rails (2 pcs.)**  
Galvanised steel shelves (72 x 24.5 cm) are suspended in the support rails.  
Max. 4 shelves per wheelie bin box possible.

Technical data and detailed information can be found on page 115.



Alex® Duo, metallic quartz grey  
(with floor kit as accessory)

# Alex® Duo

## Double Wheelie Bin Box

### Design Meets Practicality

Nothing spoils the image of a perfectly manicured front garden more than visible wheelie bins. Thanks to Biohort, these can be concealed behind a modern, smooth front. The Alex® Duo offers an ideal solution for waste separation, promotes organisation, and enhances the overall appearance of your outdoor space.



Alex® Duo double wheelie bin box,  
metallic quartz grey

Catch bar for tipping out the  
wheelie bin



### Advantages

- Integrated ventilation

### Security:

- Dual locking mechanism with T-handle cylinder lock
- Rainwater proof

### Standard Features:

- Gas spring assisted door
- Catch bar for tipping out the wheelie bin
- Plug-in ground rail for positioning the wheelie bin wheels
- Organiser system fitted inside the door (incl. 6 hooks)



Metallic Silver



Metallic Quartz Grey



Metallic Dark Grey

### Size (in cm)

#### Door opening:

129 x 118 cm (W x H)

#### Storage capacity:

- 1 x 120 L wheelie bin
- 1 x 240 L wheelie bin
- 2 x 120 L wheelie bins
- 2 x 240 L wheelie bins

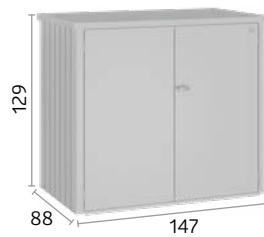

### ★ Optional Accessories



#### Floor Kit

Aluminium floor frame, aluminium floor panels and threshold access ramp.

The aluminium floor panels serve as a functional floor and is underlaid with XPS hard foam boards (not included in delivery).



#### Shelves / Supports Rails (2 pcs.)

Shelf are suspended in the support rails.

Technical data and detailed information can be found on page 116.



StoreMax® size 190, metallic silver

# StoreMax®

## Designer Cover for the Wheelie Bins

### Elegant Functionality

Up to three 240 L wheelie bins can be hidden behind the easily gliding roller shutters. The two-part opening system allows for convenient filling of the concealed bins via the separately accessible top roller shutter – and easy removal for emptying thanks to the option of fully opening the unit.



The top shutter can be opened separately.  
To fully open the StoreMax® the front shutter fully glides back.



## Advantages

- Shutter made from aluminium

### Security:

- Dual locking mechanism with T-handle cylinder lock
- Rainwater proof

### Functionality:

- Easy operation due to spring support

### Standard Features:

- Tool holder on the inside of the side wall



Metallic Silver



Metallic Quartz Grey



Metallic Dark Grey

## Sizes (in cm)

### Storage capacity:

Size 120: 2 x 120 L wheelie bin

Size 160: 3 x 120 L wheelie bins or 2 x 240 L wheelie bins (sideways)

Size 190: 3 x 120 L wheelie bins or 3 x 240 L wheelie bins

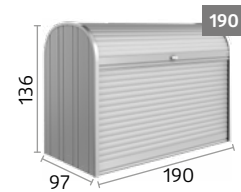
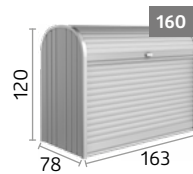
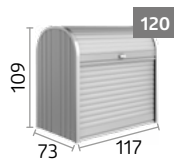

## ★ Optional Accessories



### Corner Shelf Set

(suitable for size 120 & 160)

2 shelves (triangular-shaped) with support rails, height adjustable in 5 different positions, easy to retrofit without any tools, can be fitted on the left or the right as required.

Technical data and detailed information can be found on page 115.



HighBoard size 200, metallic dark grey  
(with tool holder as accessory)

# HighBoard

## Something Nobel in the Front Garden

### The Unsightly Beautifully Stowed

Wheelie bins are not easy on the eye – unless they are hidden in noble industrial design. Additionally, the HighBoard allows for easy filling and emptying of the bins with its spacious doors and the additional lid opening. And the robust cylinder lock prevents foreign waste from being deposited.

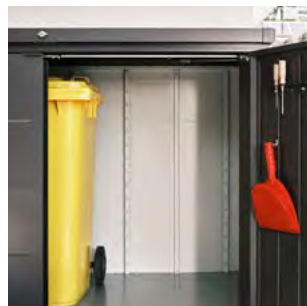
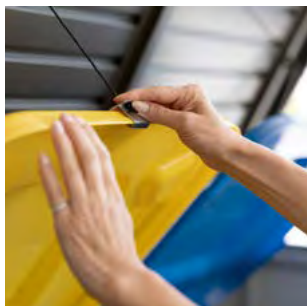



### Advantages

- Screw and rivet free surfaces
- Security:**
- Locking mechanism with turn knob cylinder lock
  - Rainwater proof
- Functionality:**
- Comfortable lid opening with gas spring
  - The elegant lid with its smooth look can also be opened easily when placed directly against a wall
  - Invisible, integrated ventilation
- Standard Features:**
- Wheelie bin lid opener (3 pcs.)



Metallic Silver



Metallic Quartz Grey



Metallic Dark Grey

### Sizes (in cm)

**Door opening:**

Size 160: 140 x 100 cm (W x H)

Size 200: 167 x 110 cm (W x H)

**Storage capacity:**

Size 160: 3 x 120 L wheelie bin

Size 200: 3 x 120 L wheelie bins or  
3 x 240 L wheelie bins

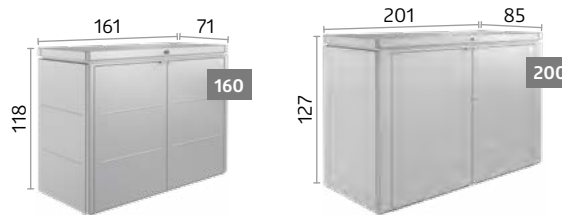

### ★ Optional Accessories



**Tool Holder**

For mounting on the inside of the doors. Max. 2 tool holders per door panel possible.



**Bin Bag Holder**

The bin bag holder enables neat and discreet storage - ideal for collecting deposit bottles or cans. Up to three bin bags can be hung side by side in the HighBoard and securely fastened.

Technical data and detailed information can be found on page 115.

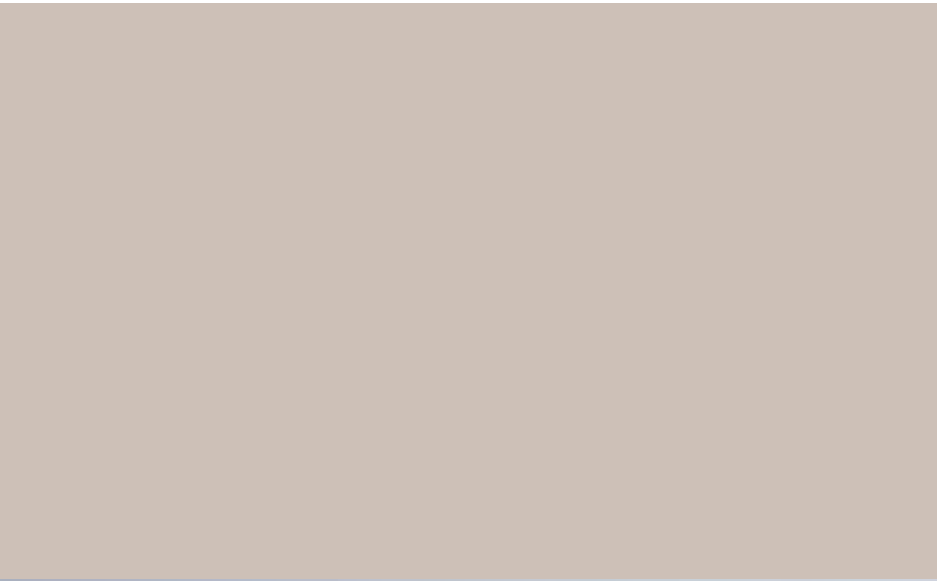



76 Pergola



123 CasaNova®

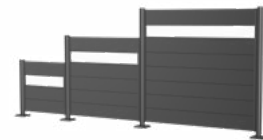

82 Privacy Screen

## Biohort

For more comfort,  
for outdoors.



Pergola 4x3, metallic dark grey  
(louvered side wall as accessory)

# Pergola

## Shade & Open Space

### For Unique Moments in Your Garden

High quality. Modern. Comfort in all weather thanks to innovative sandwich construction, which significantly reduces noise levels and heat emission from the roof. Expandable accessories such as LED lighting, sun screen or glass sliding wall provide added comfort and transform the pergola into a versatile outdoor retreat.



**Louwer structure**  
Sandwich construction with Peripor core.

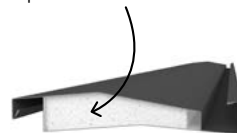



reddot design award

## Advantages

### Functionality:

- 130° adjustable louvres control the shading
- Rainwater drainage integrated in the uprights
- Significantly reduced noise generation
- Accessories can be easily retrofitted
- Less heat radiation thanks to the sophisticated design and sandwich construction of the louvres

### Standard Features:

- Manually adjustable louvres
- Preparation for LED Lighting (channel with cover)

Information on the foundation at:  
[www.biohort.com/foundation](http://www.biohort.com/foundation)

A separate product brochure is available at  
[www.biohort.com/folder-pergola](http://www.biohort.com/folder-pergola) or from your Biohort dealer.

## Optional Accessories

can be found on pages 78–79.



Metallic Quartz Grey

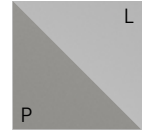

Metallic Quartz Grey /  
Metallic Silver

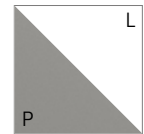

Metallic Quartz Grey /  
White



Metallic Dark Grey



Metallic Dark Grey /  
Metallic Silver

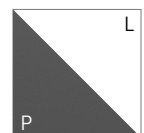

Metallic Dark Grey /  
White



White

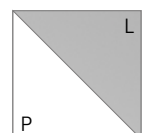

White / Metallic Silver

**L: Colour of the  
Roof Louvre**  
**P: Colour of the  
Pergola**

## Size (in cm)

The dotted lines indicate the footprint.

Height: 264 cm

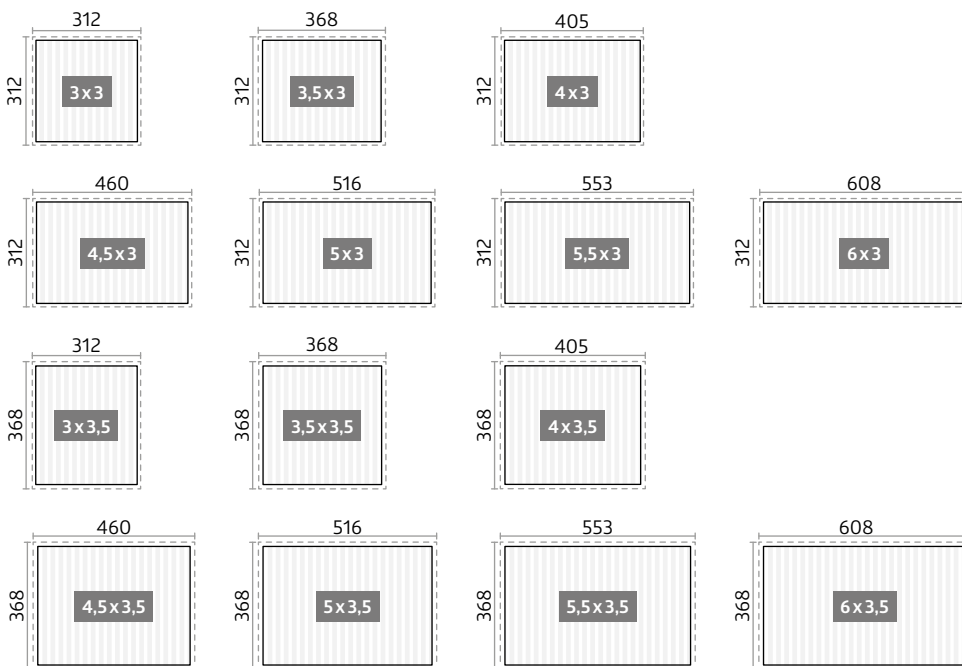

Technical data and detailed information can be found on page 117–119.

\*Please note country-specific delivery conditions for large products.

## ✔ Standard Features

## ★ Optional Accessories

		Pergola
01	<b>Manually Adjustable Louvres</b>	✔
	<b>Electric Drive for Adjusting the Roof Louvres</b>	
02	Plug-in low-voltage retrofit solution (no certified electrician required). Control set must be ordered separately. One control set (04) is required per pergola.	★
03	<b>Preparation for LED Lighting (channel with cover)</b>	✔
	<b>Control Set EU / CH / UK (including remote control)</b>	
04	Thanks to a control system developed specifically for Biohort, along with a remote control, power supply unit (max. 320 W), and extension cable, the electric drive, sun screens, and/or dimmable LED lighting can be conveniently retrofitted at any time.	★
	<b>LED Lighting</b>	
05	Four-sided continuous dimmable lighting (3000 K and 900 lm/m). Plug-in low-voltage retrofit solution (no certified electrician required). Control set must be ordered separately. One control set (04) is required per pergola.	★
	<b>Motorised Sun Screen</b>	
06	The control unit is prepared for up to three electric sun blinds and can also be retrofitted to existing systems. Control set must be ordered separately. One control set (04) is required per pergola.	★
	<b>Manual Sun Screen</b>	
07	Sun protection with ZIP function. With manual operation, installation on the side with the crank is not possible.	★
	<b>Louvred Side Wall with End Trim</b>	
08	Manually adjustable. With manual roof louver operation, installation is not possible on the side with the crank. The slatted side wall is available in various widths, allowing for flexible design options. The included end trim ensures a clean finish. If more than one slat side wall is used per pergola side, the product configurator must be used to check feasibility.	★
	<b>Clear Glass Sliding Wall</b>	
09	Durable, shatterproof glass elements made of 10 mm tempered safety glass. Convenient handling thanks to smooth-running roller bearings. Clean finish in a guide element attached to the upright. <b>Note:</b> An absolutely level foundation is essential for installation.	★
	<b>Height-adjustable Base Plate</b>	
10	To compensate for larger height differences (7,2–23 cm). All components required for height adjustment of a pergola upright are included in the delivery. When installing accessories, please ensure that the required clearance height is maintained.	★



01 Manually Adjustable Louvers

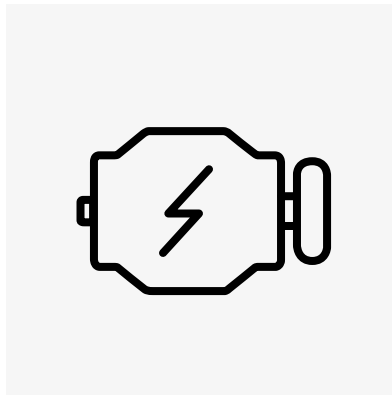

02 Electric Drive for Adjusting the Roof Louvers



03 Preparation for LED Lighting (channel with cover)



04 Control Set EU / CH / UK (including remote control)



05 LED Lighting



06 Motorised Sun Screen

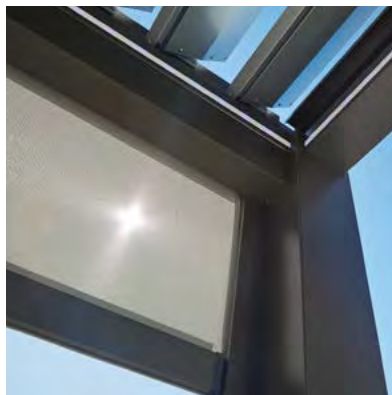

07 Manual Sun Screen



08 Louvred Side Wall with End Trim



09 Clear Glass Sliding Wall



10 Height-adjustable Base Plate

Technical data and detailed information can be found on pages 117-119.



CasaNova® 3x4, metallic dark grey

# CasaNova®

## Design, Customised to Your Requirements

### The High End Metal Building with Insulated Side Walls

Whether as a garden shed, workshop or hobby room – the CasaNova® insulated design outbuilding demonstrates unique flexibility with a wide range of configuration options and adapts exactly to your requirements. Whether you're looking for functional storage space or want to create a utility area outdoors – the CasaNova® designer garden shed makes your wishes come true with exceptional quality.

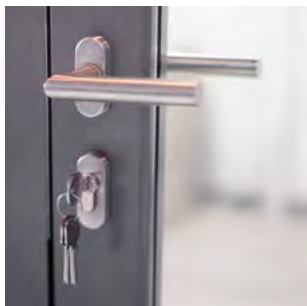

#### Insulated side walls / door panel

Sandwich element with 40 mm polystyrene core (EPS W20)

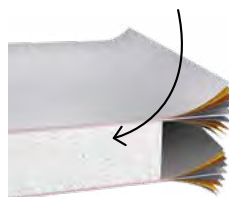



### Advantages

- Sandwich element with 40 mm core made of polystyrene (EPS W20)
- Screw and rivet free surfaces

### Security:

- Locking mechanism with stainless steel door handle
- Roof or snow load of up to 215kg/m<sup>2</sup> (minus any additional roof weight such as greenery)

### Functionality:

- Easy to heat thanks to thermal insulation; U-value of side walls: 0.76 W/(m<sup>2</sup>K)
- Door hinge position on the left or right available
- Large selection of accessories
- Ventilation via acrylic glass panel which can be opened
- Gas spring assisted door



Metallic Quartz Grey



Metallic Dark Grey

Configure your CasaNova® now!  
[www.biohort.com/configurator](http://www.biohort.com/configurator)

A separate product folder is available at  
[www.biohort.com/casanova-folder](http://www.biohort.com/casanova-folder) or from your Biohort dealer.

### Sizes (in cm, exterior dimensions incl. roof overhang)

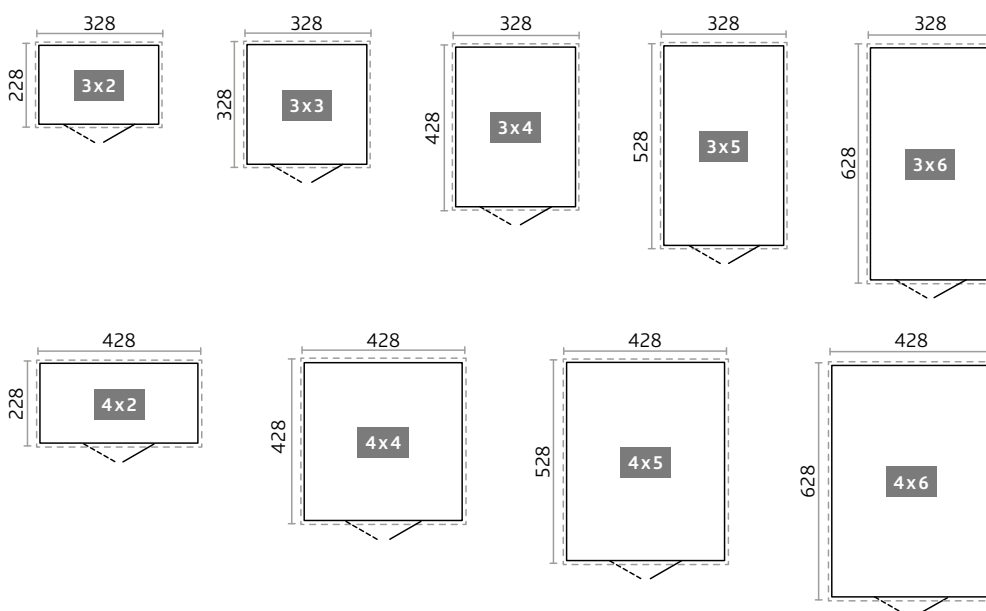

Technical data and detailed information can be found at [www.biohort.com/casanova](http://www.biohort.com/casanova)

\*Please note country-specific delivery conditions for large products.



Privacy screen with acrylic glass panel, metallic dark grey

# Privacy Screen

## Decorative Eye-Catcher

### A Piece of Privacy

Our privacy screen not only protects against curious eyes, it also offers protection from wind and direct sunlight. Thanks to the simple plug-in system, the elements can be individually expanded. Regardless of whether it is free-standing or directly on a house wall – the Biohort Privacy Screen is the perfect boundary for your garden oasis.

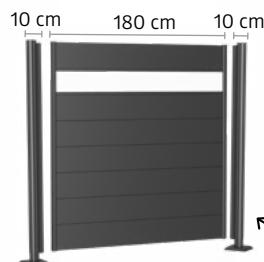

**Privacy screen consisting of:**

Wall panels and posts

The posts can be used as side end posts, corner posts, or connecting posts between two privacy panels.



## Advantages

- Individually configurable
- Extremely durable
- Simple assembly
- Privacy, wind and sun screen
- Screw and rivet free surfaces

## Security:

- High wind resistance due to well-thought-out ground anchoring

## Functionality:

- Free-standing assembly or connection to house wall or similar possible
- Mounting accessories optionally available (see technical details)



Metallic Silver



Metallic Quartz Grey



Metallic Dark Grey

## Sizes (in cm)

### Posts:

Height adjustable: up to 25 cm  
Diameter: 10 cm

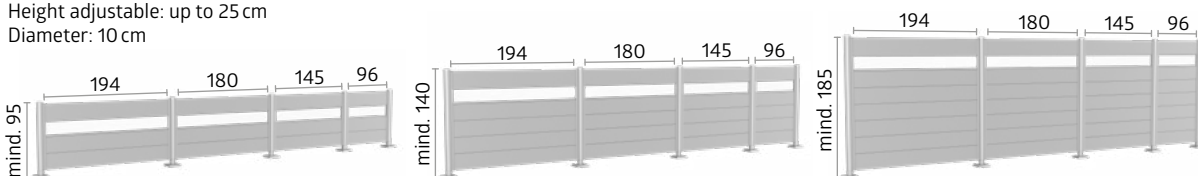

## ★ Optional Accessories



### Components

Wall panels (with or without glass panels) and the appropriate posts are required for a privacy screen.



### Privacy Screen Combinations

The privacy screen can be extended both in a straight line and in different angles.

All widths and heights are compatible with each other, making height gradations also possible.



### Variant 1: Post for anchoring, height-adjustable up to 25 cm

The base plate is bolted to a frost-proof concrete foundation using threaded rod anchors (optional available). Assembly on terrace tiles or wood/WPC boards is not sufficient.

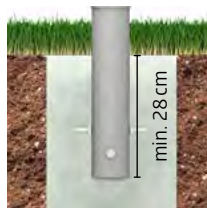

### Variant 2: Post for setting in concrete, height-adjustable up to 25 cm

With this variant, the post is set directly into the concrete foundation.

Size of foundation points: minimum 50 x 50 cm (may vary depending on soil conditions)

Minimum depth: 80 cm (varies depending on the height of the privacy screen)

Technical data and detailed information can be found on page 120.

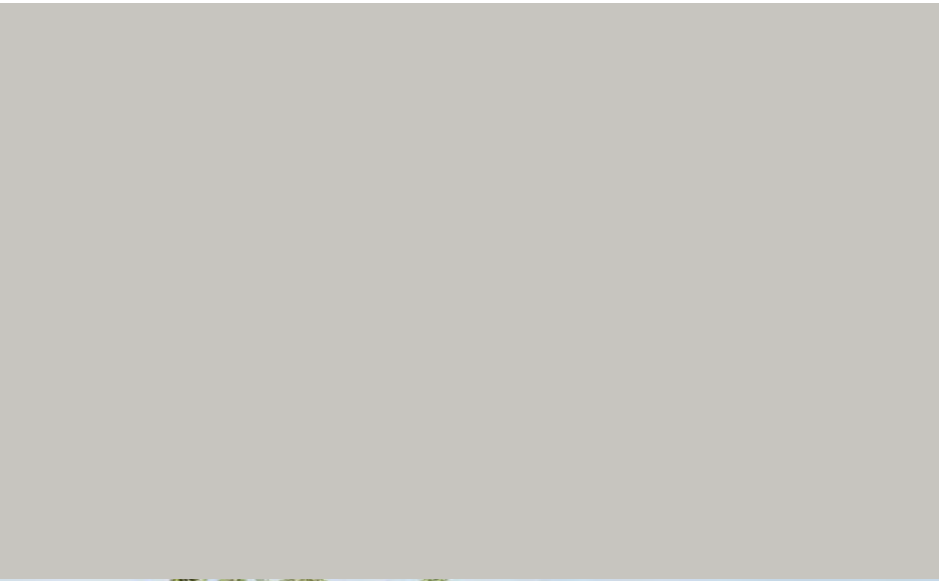



86 Florentina Greenhouse

## Biohort

For a rich harvest,  
for outdoors.





Florentina Greenhouse size 2 x 1<sup>MAXI</sup>, metallic dark grey  
(with skirting, trellis and plant pot set as accessories)

NEW

# Florentina Greenhouse

## Optimum Protection for Delicate Plants

### Designer Greenhouse for Small Spaces

Compact greenhouse for tall-growing plants – ideal where space is limited. The well-designed combination of raised bed and custom-fit greenhouse top creates a protected microclimate, offering ideal conditions for healthy growth and an extended gardening season. Accessories such as trellis or irrigation system assist with plant care in a targeted and efficient way. Gardening can be functional – and look good. With its high-quality workmanship and modern design, the greenhouse becomes an architectural accent in the garden. Even in a small space, there is room for great things.

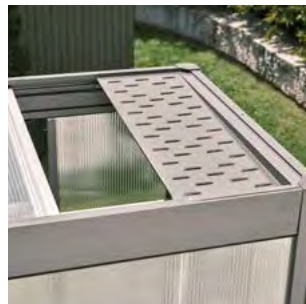
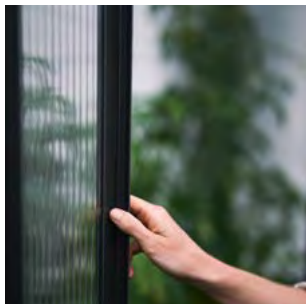



## Advantages

- Unique design with a smooth surface and no visible screws or rivets
- Back-friendly gardening thanks to comfortable working height

## Functionality:

- Protected microclimate through regulated air circulation and natural lighting conditions
- Can be retrofitted to existing Biohort raised beds
- Efficient use of space for diverse planting

## Standard Features

- UV-resistant twin-wall panels
- Ventilation through two roof windows

## Optional Accessories

can be found on pages 94–95.



Metallic  
Quartz Grey



Metallic Dark  
Grey

## Sizes (in cm)

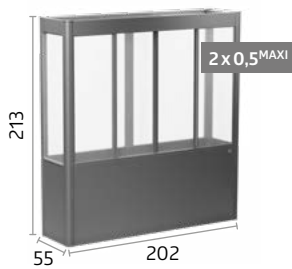

### Florentina Greenhouse attachment as an extension for your Biohort raised and planting bed

The matching Florentina Greenhouse extension is available for the Biohort raised bed 2x0.5m, 2x1m and the Belvedere® 200<sup>MAXI</sup>. It creates ideal conditions for nurturing and protecting your plants as they grow. With just a few simple steps, your raised bed transforms into a compact greenhouse.

Technical data and detailed information can be found on pages 123.

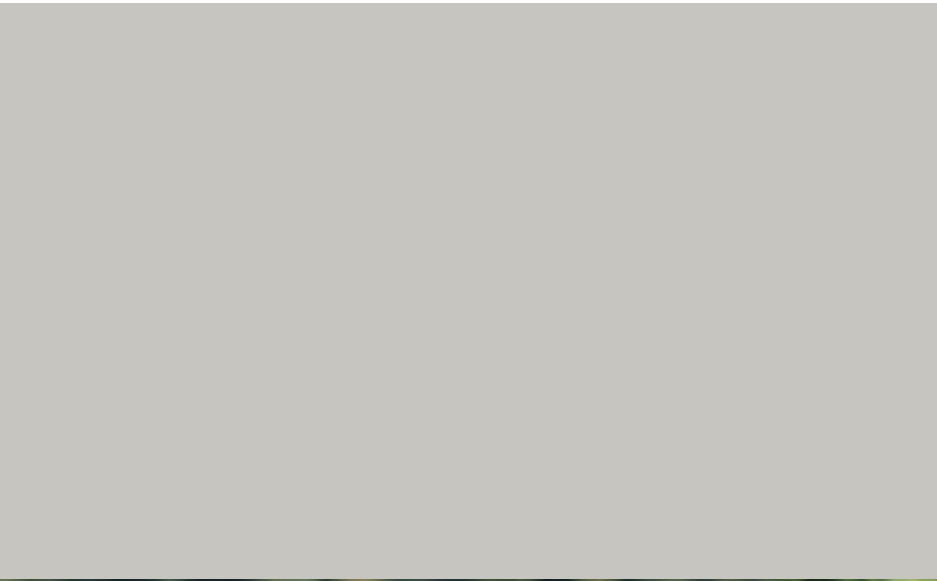



90 Belvedere®



92 Raised Bed



96 DaVinci®

## Biohort

For blooming variety,  
for outdoors.



Belvedere® size 200<sup>MAXI</sup>, metallic quartz grey  
(with skirting as accessories)

# Belvedere®

## Experiencing Design

### The Eye-Catcher for Your Terrace

With a width of just 0.5 meters, the Belvedere® planting bed opens up space for creative ideas: as a vibrant room divider, it structures terraces and gardens and also fits perfectly on balconies. This gives you completely new design options and you can also save on potting soil with the standard intermediate floor.





### Advantages

- Extremely durable
- Screw and rivet free surfaces

### Functionality:

- Skirting, trellis, privacy screen and planting insert optionally available
- Quickly assembled

### Standard Features:

- Intermediate floor
- Opening for irrigation hose



Metallic Silver



Metallic Quartz Grey



Metallic Dark Grey

### Optional Accessories

can be found on pages 94–95.

### Sizes (in cm)

Tip: All sizes are available in three different heights!

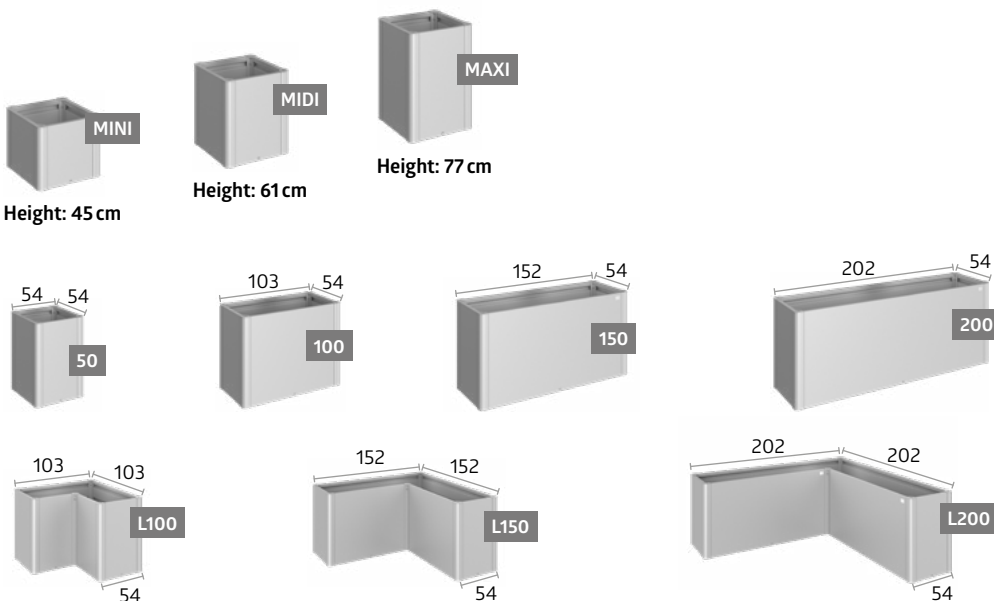

Technical data and detailed information can be found on pages 122–123.



Raised bed 2 x 1, metallic quartz grey  
(with skirting and slug guard as accessories)

New – turn your raised bed into a stylish greenhouse.  
Details at Accessories

# Raised Bed

## Clever Cultivation

### The Best Conditions for a Bountiful Harvest

Raised beds make cultivation easier and maximise the harvest – but only the Biohort raised bed perfects the most beautiful hobby in the world with intelligent design and practical functionality. Thanks to the optional intermediate floor, you need less potting soil. Ingenious details add to the eye catching effect of this product, which offers more than just beauty!



Size 2 x 1, metallic quartz grey with cold frame extension in metallic quartz grey



### Advantages

- Extremely durable
- Optimum working height
- Screw and rivet free surfaces

### Functionality:

- Cold frame attachment, intermediate floor, slug guard, trellis and skirting optionally available
- Sliding side walls make it easy to empty
- Opening for irrigation hose
- An ideal place to recycle garden cuttings
- Quickly assembled – only 8 screws



Metallic Silver



Metallic Quartz Grey



Metallic Dark Grey

### Optional Accessories

can be found on the pages 94–95.

### Size (in cm)

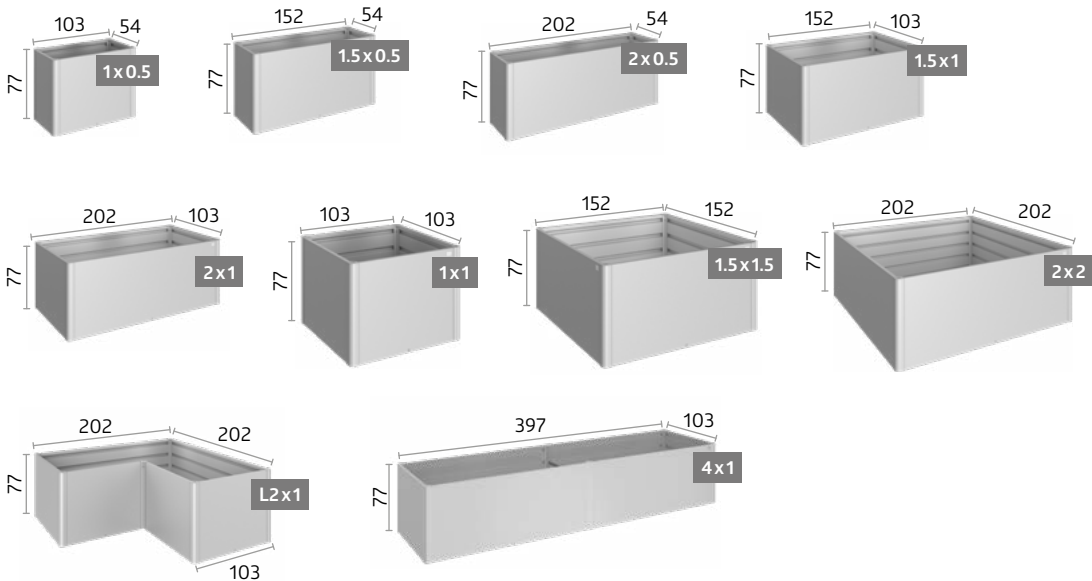

Technical data and detailed information can be found on pages 121–122.

## ✔ Standard Features

## ★ Optional Accessories

		Belvedere®	Raised bed	Florentina Greenhouse
01	<b>Sliding Panel*</b> Easy to empty thanks to sliding panel.	✔	✔	
02	<b>Preparation for Irrigation</b> Opening for watering hose on the narrow side (size: 17 x 17 mm).	✔	✔	✔
03	<b>Irrigation System</b> The Micro-Drip system ensures targeted and water-saving irrigation in greenhouses, raised beds and planting beds. The water is delivered directly to the roots of the plants via fine drippers. Scope of delivery: 1 x 2-way manifold, 10 m ½-inch supply hose, 5 m ¼-inch distribution tubing, 10 x T-connectors, 5 x drip emitters, 5 x spray nozzles with ground stakes, 5 x end plugs, 1 x sealing tape.	★	★	★
04	<b>Slug Guard*</b> It is placed on top of the raised bed. Can be combined with a cold frame extension (06). Not available for L-sizes and raised bed 4 x 1.	★	★	
05	<b>Intermediate Floor*</b> The intermediate floor reduces the volume of the bed and the soil filling required, saving both money and valuable time. It is placed on the second corrugation during assembly.	✔	★	★
06	<b>Cold Frame Extension*</b> Efficient frost protection with 4 easily removable sliding panels. The cold frame extension is storm-proof and designed to direct rainwater into the raised bed. Cannot be combined with Trellis (10). Only suitable for size 2 x 1.		★	
07	<b>Skirting*</b> The skirting is mounted on the floor frame and placed on the lawn. The raised bed is then placed on the skirting and fastened (cannot be installed afterwards). Width: 6.7 cm. Not available for raised bed 4 x 1.	★	★	★
08	<b>Planter Insert</b> Plastic insert (size: 0.5 x 0.5 m) for easier planting, is placed on the intermediate floor. Holes for drainage can be drilled without any problems.	★		
09	<b>Plant Pot Set</b> Practical plant pots for side mounting in the greenhouse – perfect for herbs and seedlings. This creates additional planting space without taking up ground area. Available only for the Florentina greenhouse 2 x 0.5 and 2 x 1, and/or the Florentina greenhouse extension 2 x 0.5 and 2 x 1.	★	★	★
10	<b>Trellis*</b> The trellis is attached directly to the raised/planting bed. Cannot be combined with cold frame extension (06) or slug guard (04). Height: 91 cm	★	★	
11	<b>Privacy Screen* with or without Tinted Glass Panel</b> In conjunction with the planting bed, the privacy screen forms a decorative boundary and serves not only as a privacy but also as a windscreen. Cannot be combined with cold frame extension (06) or slug guard (04). Height: 91 cm.  Note: In places exposed to the wind, the product with privacy screen is at high risk of tipping, so it is essential to ensure that it is adequately fixed to the ground using the fixing materials supplied.	★	★	
12	<b>Florentina Greenhouse Extension</b> The well-designed combination of raised bed and custom-fit greenhouse top creates a protected microclimate, offering ideal conditions for healthy growth and an extended gardening season.	★	★	
13	<b>Weather Protection Plate</b> The weather protection panel shields your harvest from heavy rain while allowing continuous ventilation for a stable internal climate. Available only for the Florentina greenhouse 2 x 0.5 and 2 x 1, and/or the Florentina greenhouse extension 2 x 0.5 and 2 x 1.	★	★	★
14	<b>Automatic Ventilation</b> The automatic ventilation opens both roof windows independently as soon as it gets too hot inside – controlled by a pressure spring. Available only for the Florentina greenhouse 2 x 0.5 and 2 x 1, and/or the Florentina greenhouse extension 2 x 0.5 and 2 x 1.	★	★	★
15	<b>Florentina Trellis</b> The trellis provides support for tall-growing plants, helping them stand upright securely. The cord can be flexibly hooked into the existing frame and adjusted to suit individual needs. Available only for the Florentina greenhouse 2 x 0.5 and 2 x 1, and/or the Florentina greenhouse extension 2 x 0.5 and 2 x 1.	★	★	★

\*Made from galvanised, polyamide coated steel



01 Sliding Panel



02 Preparation for Irrigation



03 Irrigation System



04 Slug Guard



05 Intermediate Floor



06 Cold Frame Extension



07 Skirting



08 Planter Insert



09 Plant Pot set



10 Trellis



11 Privacy Screen with or without Tinted Glass Panel



12 Florentina Greenhouse Extension



13 Weather Protection Plate



14 Automatic Ventilation



15 Florentina Trellis

Technical data and detailed information can be found on pages 121–123.



DaVinci®, Metallic Quartz Grey

# DaVinci®

## Flexible Planter Box System

### Limitless Individuality

Design the flexible DaVinci® planter box system as you wish. From planting bed with height graduations to privacy screen and terrace borders, there are no limits to the possibilities. The basic modules in different versions can be individually combined. With the help of the 3D-Configurator, your DaVinci® planter box system can be visualized with just a few clicks.



### DaVinci® as a flower bed

Combination of different heights and lengths





## Advantages

- Individually configurable
- Extremely durable
- Available in different lengths, heights and combinations
- Screw and rivet free surfaces

### Functionality:

- Privacy screen and trellis can be placed as desired
- Ideal as a terrace border

### Standard Features:

- Intermediate floor
- Opening for irrigation hose



Metallic Silver



Metallic Quartz Grey



Metallic Dark Grey

## ★ Optional Accessories

can be found on pages 94–123.

## 3 Heights, 4 Lengths, 3 Colours and Countless Possibilities

Heights ranging from 45 cm to 77 cm and lengths from 50 cm to 200 cm.

Thanks to the modular construction, there are no limits to your wishes. The basic modules can be arranged in any order. Privacy screen and trellis can be positioned freely according to your expectations.

## Flexible, Convenient and Versatile Configurations

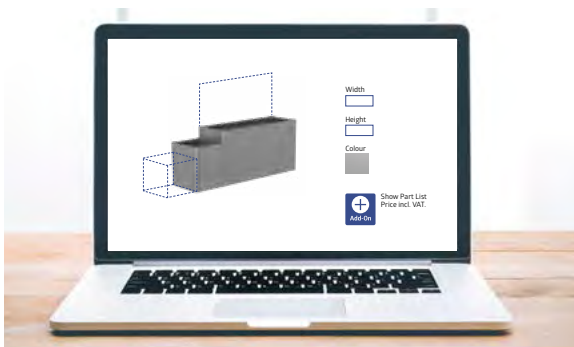

Configure your own Planter Box System DaVinci® now!  
[www.biohort.com/configurator](http://www.biohort.com/configurator)



### DaVinci® as a privacy screen

Combination of different heights, lengths and two privacy screens.



### DaVinci® as a terrace border

Combination of different heights, lengths and two trellises.

Technical data and detailed information can be found at [www.biohort.com](http://www.biohort.com)

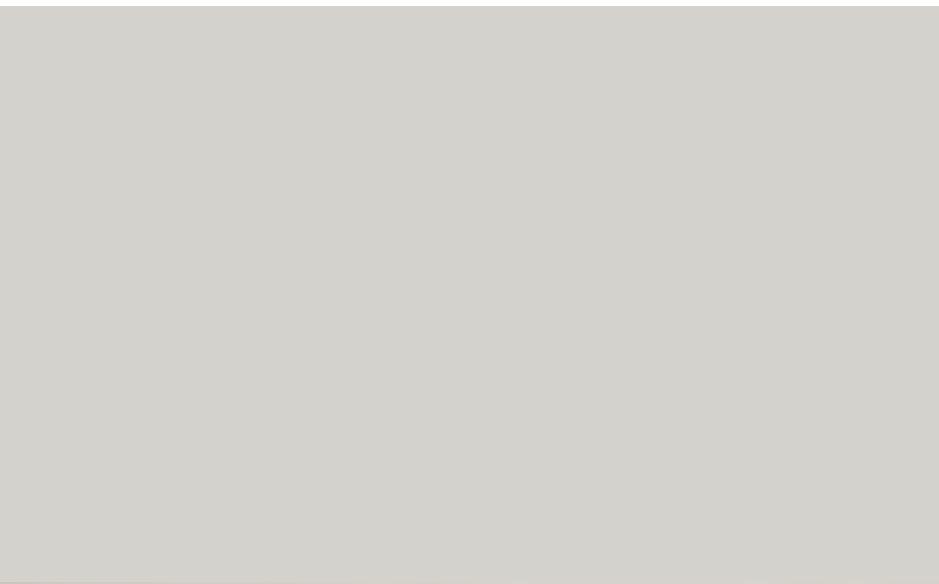



**100** WoodStock®



**102** Charly® Robotic  
Lawnmower Garage



**103** MonAmi® Composter



## Biohort

For the best support,  
for outdoors.



WoodStock® size 150, metallic quartz grey  
(with back wall and aluminium floor panels as accessories)

# WoodStock®

## All-rounder

### Firewood Storage and Equipment Locker in One

Nothing conjures up a cosier atmosphere than a blazing fire burning in the chimney on a cold winters day. But where to store the firewood? The WoodStock® provides the tidy and lasting solution for this question. With its versatile accessories, it transforms into a stylish equipment locker during the summer.



WoodStock® size 300,  
metallic quartz grey

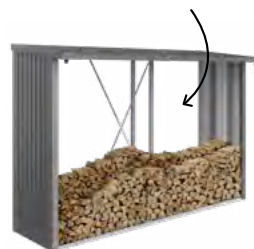



## Advantages

- Wide range of accessories available
- Security:**
- Integrated gutter on the front side
  - Universally applicable for garden tools
  - Stability because of massive aluminium frame
- Functionality:**
- Screws and anchors for fixation to the ground



Metallic Silver



Metallic Quartz Grey



Metallic Dark Grey

## Sizes (in cm)

### Volume:

Size 150: 2.1m<sup>3</sup>

Size 230: 3.1m<sup>3</sup>

Size 300: 4 m<sup>3</sup>

Firewood storage possible in two rows  
(maximum log length: 35 cm)

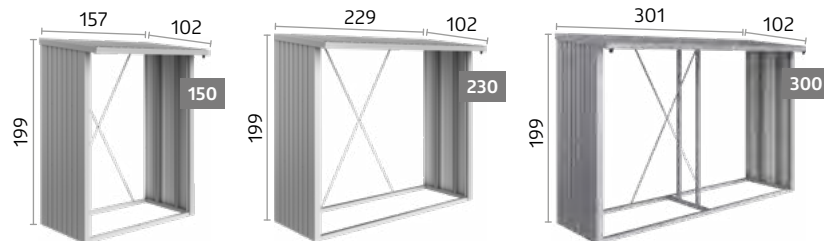

## ★ Optional Accessories

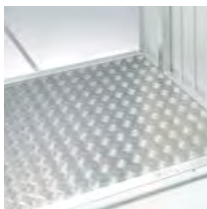

### Aluminium Floor Panels

High quality aluminium chequer plate, protects the stored wood and gardening equipment from moisture.



### Back Wall

Made from galvanised, polyamide coated steel.



### Door Package

(suitable for size 150 & 230)

Double door fitted with T-handle cylinder lock and organiser system on the inside of the doors, Door opening: 135 x 171 cm (W x H).

Technical data and detailed information can be found on page 113.



Charly® size 2



**Side Walls:**  
Metallic Dark Grey



**Lid:**  
Metallic Quartz Grey

# Charly® Robotic Lawnmower Garage

A shelter from the rain is not only the least that your hard-working robotic lawn mower deserves, but is also highly recommended for the protection of your robot! Suitable for many commercially available models, Charly® robot garage offers all the convenience that robots and owners need. The folding lid offers easy access to the control panel.

## Advantages

### Security:

- Folding-locking mechanism
- Corner protectors
- Ground screw fasteners

### Functionality:

- Easy access to the control panel due to folding lid

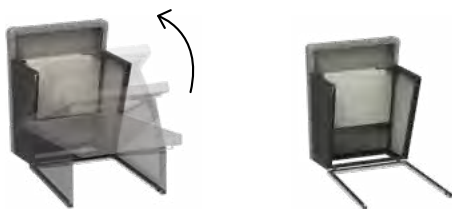

### Folding-locking Mechanism

The folding lid with its locking mechanism offers easy access to the control panel.

## Size (in cm)

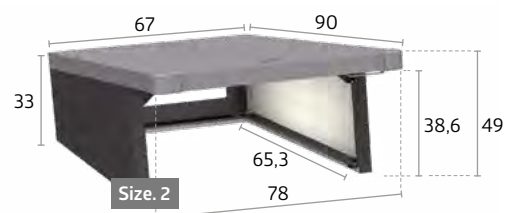

Technical data and detailed information can be found on page 123.



Metallic Dark Grey



MonAmi®, metallic dark grey

# MonAmi® Composter

As “my friend” in the garden, the MonAmi® composter combines functionality with stylish appearance: elegant, smooth surfaces on the outside, inside everything required for efficient composting. Two centrally placed ventilation pipes create a chimney effect and ensure a reliable circulation of air, meanwhile the circumferential gap underneath the cover ensures that heat is transferred out of the composter. Even composting can now look great!

## Advantages

- Extremely durable
- Screw and rivet free surfaces

## Standard Features:

- Ventilation system ensures an optimal rotting process
- Sliding front wall panel makes it convenient and easy to empty
- Comfortable lid with gas spring



### Ventilation Pipes

The integrated ventilation pipes provide an optimal supply of oxygen and circulation of air, which is essential for efficient composting.



### Sliding Panel

Sliding front wall panel makes it convenient and easy to empty.

## Size (in cm)

Volume: 725 L

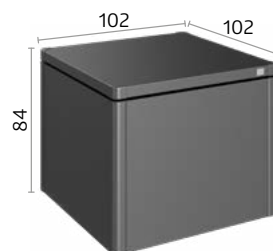

Technical data and detailed information can be found on page 123.



Made in Austria.



Biohort has always produced in Austria, and we are very proud of this fact. There are now three large sites in the western Mühlviertel region of Upper Austria. We have deliberately chosen this region with a highly skilled workforce. This enables us to produce in the best possible quality.

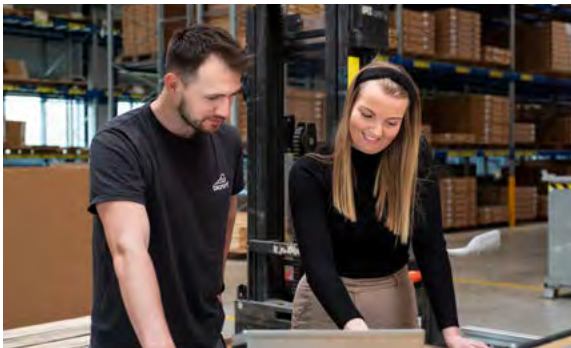

Made in Austria

# Sustainability is Our Claim

At Biohort, sustainability is a core part of the company's strategy – ecological, economic, and social. Production is powered entirely by green electricity, with one third generated by the company's own photovoltaic systems. Additionally, waste heat from compressed air systems is used for heat recovery.

The company's own biomass heating plant has been supplying the entire St. Martin site with climate-friendly heat since 2023, replacing approximately 200,000 m<sup>3</sup> of natural gas annually.

Biohort also prioritizes environmental compatibility in its manufacturing – with no wastewater or dust emissions, no protective films, and maximum efficiency thanks to lean management.



All internal transport is fully electric, and many company vehicles have already been converted to electric drive. Short transport routes, regional suppliers, and direct delivery without intermediate storage further reduce emissions.

All packaging is 100% recyclable and designed to meet high recycling standards within the EU. The steel used is durable, energy-efficient in production, and infinitely recyclable – without any loss of quality.





“We are fully aware of the responsibility we bear as a manufacturing company – towards the environment, our employees, and our customers around the world.”  
– DI Maximilian Priglinger, Managing Director

## Garden Sheds

Europa	Size	Exterior Dimensions*	Interior Dimensions	Foundation Dimensions	Weight (kg)	EAN Code				
		W x L x H (cm)	W x L x H (cm)	W x L (cm)		Metallic Silver	Metallic Quartz Grey	Metallic Dark Grey	Dark Green	
	Door opening: 135 x 170 cm (W x H)									
	1	172 x 84 x 196	150 x 78 x 188	155 x 83	90,4	9003414 29010 5	9003414 22010 2	9003414 24010 0	9003414 23010 1	
	2	172 x 156 x 196	150 x 150 x 188	155 x 155	115,2	9003414 29020 4	9003414 22020 1	9003414 24020 9	9003414 23020 0	
	3	244 x 156 x 203	222 x 150 x 195	227 x 155	139,4	9003414 29030 3	9003414 22030 0	9003414 24030 8	9003414 23030 9	
	4	244 x 228 x 203	222 x 222 x 195	227 x 227	167,8	9003414 29040 2	9003414 22040 9	9003414 24040 7	9003414 23040 8	
	5	316 x 228 x 209	294 x 222 x 202	299 x 227	202,6	9003414 29050 1	9003414 22050 8	9003414 24050 6	9003414 23050 7	
	6	244 x 300 x 203	222 x 294 x 195	227 x 299	197,8	9003414 29060 0	9003414 22060 7	9003414 24060 5	9003414 23060 6	
	7	316 x 300 x 209	294 x 294 x 202	299 x 299	233,9	9003414 29070 9	9003414 22070 6	9003414 24070 4	9003414 23070 5	
	2A	244 x 84 x 203	222 x 78 x 195	227 x 83	112,2	9003414 29080 8	9003414 22080 5	9003414 24080 3	9003414 23080 4	
	4A	316 x 156 x 209	294 x 150 x 202	299 x 155	165,1	9003414 29090 7	9003414 22090 4	9003414 24090 2	9003414 23090 3	
<b>Additions</b>	Side canopy for Europa garden shed									
	2,3,4A	150 x 156 x 170			21,7	9003414 42019 9	9003414 42012 0	9003414 42014 4	9003414 42040 3	
	4,5	150 x 228 x 170			27,5	9003414 42029 8	9003414 42022 9	9003414 42024 3	9003414 42050 2	
	6,7	150 x 300 x 170			35,2	9003414 42039 7	9003414 42032 8	9003414 42034 2	9003414 42060 1	

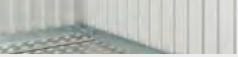
\*highest point, incl. roof overhang





Foundation Accessories / Foundations Europa	EAN Code		EAN Code		EAN Code		EAN Code	
	Aluminium Floor Frame	Aluminium Floor Panels	SmartBase	SmartBase <sup>PLUS</sup>				
1	9003414 41010 7	9003414 48010 0	9003414 43901 6	9003414 43401 1				
2	9003414 41020 6	9003414 48020 9	9003414 43906 1	9003414 43406 6				
2A	9003414 41080 0	9003414 48080 3	9003414 43936 8	9003414 43436 3				
3	9003414 41030 5	9003414 48030 8	9003414 43912 2	9003414 43412 7				
4	9003414 41040 4	9003414 48040 7	9003414 43918 4	9003414 43418 9				
4A	9003414 41090 9	9003414 48090 2	9003414 43942 9	9003414 43442 4				
5, 6	9003414 41050 3	9003414 48050 6	9003414 43923 8	9003414 43423 3				
7	9003414 41070 1	9003414 48070 4	9003414 43930 6	9003414 43430 1				
Note: Hammer drills can be rented from any well-equipped specialist, however the drill bit required is available from Biohort.								
Drill Bit Ø 40 x 570 mm for SDS-MAX chuck Ø 18 mm (for SmartBase <sup>PLUS</sup> )				9003414 43410 3				
Note: If the floor frame is laid directly on a gravel base (approx. 10 cm gravel, without foundation or slabs), ground anchors are required for securing to the ground. Storm resistance must be ensured by the customer. For sizes 1: 4 pcs. in total; for sizes 2, 2A: 6 pcs. in total; for sizes 3, 4, 4A: 8 pcs. in total; for sizes 5, 6, 7: 10 pcs. in total.								
Ground Anchor	4 pieces per package	9003414 41004 6						
	6 pieces per package	9003414 41006 0						

Accessories	Dimensions W x L x H (cm) / Colour		EAN Code
Rainwater Downpipe Set		Metallic Silver	9003414 44070 8
		Metallic Quartz Grey	9003414 44080 7
		Metallic Dark Grey	9003414 44050 0
		Dark Green	9003414 44040 1
Window Unit		Metallic Silver	9003414 43060 0
		Metallic Quartz Grey	9003414 43080 8
		Metallic Dark Grey	9003414 43050 1
		Dark Green	9003414 43040 2

Made from hot-dip galvanised, polyamide coated steel plate



Shelf Support Rails	2 pieces per package	4 x 4 x 173	9003414 46020 1
Shelves	2 pieces per package	72 x 25,5 x 7,5	9003414 45010 3
	4 pieces per package	72 x 24,5 x 7,5	9003414 45020 2
	2 pieces per package	72 x 43,5 x 12,5	9003414 45030 1
Folding Table		69,2 x 57,5 x 40	9003414 40011 5
Suspension Basket	With wall bracket	67 x 34 x 20	9003414 47071 2
Bin Bag Holder		72 x 44,6 x 16,2	9003414 45016 5
Hook Set	One combi, handle and shovel hook each	72 x 17 x 73	9003414 47070 5
Tool Hangers	4 pieces per package	13 x 9,5 x 30	9003414 47020 0
Door Baskets	2 pieces per package	34 x 10 x 9,5	9003414 46025 6
Shelf Baskets	2 pieces per package	72 x 16 x 11	9003414 46026 3
Electric Mounting Panel		28 x 6 x 172,5	9003414 46030 0
Solar Light		15 x 10 x 5	9003414 46042 3
LED Light		44 x 4 x 1,5	9003414 46041 6
Threshold Access Ramp	Only with double door and floor frame	135 x 14,5 x 7	9003414 41000 8
BikeLift®	Standard	16,9 x 43,1 x 185,4	9003414 49050 5
	With swivel mount Can only be mounted centrally on the back wall	16,9 x 57,4 x 184,6	9003414 49051 2
Bicycle Hanger BikeMax	1 piece per package		9003414 49010 9
	2 pieces per package	6 x 14,5 x 173	9003414 49020 8
BikeHolder	Set for 3 bikes	72 x 10 x 33	9003414 49012 3

Accessories	For Size	Dimensions W x L x H (cm)	EAN Code
Gas Spring Set	1 / 2 / 3 / 4 / 6	170 x 13,5 x 9,5	9003414 <b>40008</b> 5
	4A / 5 / 7	170 x 13,5 x 9,5	9003414 <b>40009</b> 2
PV Mounting Preparation for Side Wall	With 3 vertical wall rails	3 x 3,5 x 175	9003414 <b>47022</b> 4

HighLine®	Size	Exterior Dimensions*	Interior Dimensions	Foundation Dimensions	Weight (kg)	EAN Code		
		W x L x H (cm)	W x L x H (cm)	W x L (cm)		Metallic Silver	Metallic Quartz Grey	Metallic Dark Grey
	With standard door, door opening: 76 x 182 cm (W x H), right door hinge							
	H5	155 x 275 x 222	132 x 252 x 210	137 x 257	219,8	9003414 <b>83010</b> 3	9003414 <b>88010</b> 8	9003414 <b>84010</b> 2
	H1	275 x 155 x 222	252 x 132 x 210	257 x 137	211,5	9003414 <b>83020</b> 2	9003414 <b>88020</b> 7	9003414 <b>84020</b> 1
	H2	275 x 195 x 222	252 x 172 x 210	257 x 177	229,0	9003414 <b>83030</b> 1	9003414 <b>88030</b> 6	9003414 <b>84030</b> 0
	H3	275 x 235 x 222	252 x 212 x 210	257 x 217	264,5	9003414 <b>83040</b> 0	9003414 <b>88040</b> 5	9003414 <b>84040</b> 9
	H4	275 x 275 x 222	252 x 252 x 210	257 x 257	280,6	9003414 <b>83050</b> 9	9003414 <b>88050</b> 4	9003414 <b>84050</b> 8
	H5	275 x 315 x 222	252 x 292 x 210	257 x 297	314,8	9003414 <b>83060</b> 8	9003414 <b>88060</b> 3	9003414 <b>84060</b> 7
	H6	314,3 x 314,3 x 221	292 x 292 x 210	297 x 297	363,2	9003414 <b>83070</b> 7	9003414 <b>88070</b> 2	9003414 <b>84070</b> 6
	With double door, door opening: 155 x 182 cm (W x H)							
	H1	275 x 155 x 222	252 x 132 x 210	257 x 137	223,9	9003414 <b>83029</b> 5	9003414 <b>88029</b> 0	9003414 <b>84029</b> 4
	H2	275 x 195 x 222	252 x 172 x 210	257 x 177	241,4	9003414 <b>83039</b> 4	9003414 <b>88039</b> 9	9003414 <b>84039</b> 3
	H3	275 x 235 x 222	252 x 212 x 210	257 x 217	276,9	9003414 <b>83049</b> 3	9003414 <b>88049</b> 8	9003414 <b>84049</b> 2
	H4	275 x 275 x 222	252 x 252 x 210	257 x 257	293,0	9003414 <b>83059</b> 2	9003414 <b>88059</b> 7	9003414 <b>84059</b> 1
	H5	275 x 315 x 222	252 x 292 x 210	257 x 297	327,2	9003414 <b>83069</b> 1	9003414 <b>88069</b> 6	9003414 <b>84069</b> 0
H6	314,3 x 314,3 x 221	292 x 292 x 210	297 x 297	375,8	9003414 <b>83079</b> 0	9003414 <b>88079</b> 5	9003414 <b>84079</b> 9	
<b>Additions</b>	Side canopy size S for HighLine® garden shed, width: 150 cm							
	H2	150 x 195 x 222			75,8	9003414 <b>83836</b> 9	9003414 <b>88836</b> 4	9003414 <b>84836</b> 8
	H3	150 x 235 x 222			86,7	9003414 <b>83846</b> 8	9003414 <b>88846</b> 3	9003414 <b>84846</b> 7
	H4	150 x 275 x 222			94,2	9003414 <b>83856</b> 7	9003414 <b>88856</b> 2	9003414 <b>84856</b> 6
	H5, H6	150 x 315 x 222			104,1	9003414 <b>83866</b> 6	9003414 <b>88866</b> 1	9003414 <b>84866</b> 5
Side canopy size L for HighLine® garden shed, width: 282 cm								
	H2	282 x 195 x 222			115,0	9003414 <b>83036</b> 3	9003414 <b>88036</b> 8	9003414 <b>84036</b> 2
	H3	282 x 235 x 222			134,6	9003414 <b>83046</b> 2	9003414 <b>88046</b> 7	9003414 <b>84046</b> 1
	H4	282 x 275 x 222			141,3	9003414 <b>83056</b> 1	9003414 <b>88056</b> 6	9003414 <b>84056</b> 0
	H5, H6	282 x 315 x 222			155,8	9003414 <b>83066</b> 0	9003414 <b>88066</b> 5	9003414 <b>84066</b> 9
Side wall for side canopy size S and size L								
	H2	157 x 2,5 x 181			37,8	9003414 <b>83038</b> 7	9003414 <b>88038</b> 2	9003414 <b>84038</b> 6
	H3	197 x 2,5 x 181			45,6	9003414 <b>83048</b> 6	9003414 <b>88048</b> 1	9003414 <b>84048</b> 5
	H4	237 x 2,5 x 181			54,8	9003414 <b>83058</b> 5	9003414 <b>88058</b> 0	9003414 <b>84058</b> 4
	H5, H6	277 x 2,5 x 181			62,8	9003414 <b>83068</b> 4	9003414 <b>88068</b> 9	9003414 <b>84068</b> 3
Back wall for side canopy size S, width: 150 cm								
	S	134 x 4 x 181			33,8	9003414 <b>83097</b> 4	9003414 <b>88097</b> 9	9003414 <b>84097</b> 3
	Back wall for side canopy size L, width: 282 cm							
	L	266 x 4 x 181			61,2	9003414 <b>83098</b> 1	9003414 <b>88098</b> 6	9003414 <b>84098</b> 0









AvantGarde®	Size	Exterior Dimensions*	Interior Dimensions	Foundation Dimensions	Weight	EAN Code		
		W x L x H (cm)	W x L x H (cm)	W x L (cm)	(kg)	Metallic Silver	Metallic Quartz Grey	Metallic Dark Grey
	With standard door, door opening: 76 x 182 cm (W x H), right door hinge							
	A1	180 x 220 x 218	172 x 172 x 209	177 x 177	155,8	9003414 15010 2	9003414 19010 8	9003414 17010 0
	A2	180 x 260 x 218	172 x 212 x 209	177 x 217	175,7	9003414 15020 1	9003414 19020 7	9003414 17020 9
	A3	180 x 300 x 217	172 x 252 x 209	177 x 257	194,2	9003414 15030 0	9003414 19030 6	9003414 17030 8
	A4	180 x 380 x 222	172 x 332 x 209	177 x 337	237,3	9003414 15040 9	9003414 19040 5	9003414 17040 7
	A5	260 x 220 x 218	252 x 172 x 209	257 x 177	191,0	9003414 15050 8	9003414 19050 4	9003414 17050 6
	A6	260 x 260 x 218	252 x 212 x 209	257 x 217	214,5	9003414 15060 7	9003414 19060 3	9003414 17060 5
	A7	260 x 300 x 217	252 x 252 x 209	257 x 257	230,8	9003414 15070 6	9003414 19070 2	9003414 17070 4
	A8	260 x 380 x 222	252 x 332 x 209	257 x 337	281,5	9003414 15080 5	9003414 19080 1	9003414 17080 3
	With double door, door opening: A1 - A4: 139 x 182 cm (W x H), A5 - A8: 155 x 182 cm (W x H)							
	A1	180 x 220 x 218	172 x 172 x 209	177 x 177	167,0	9003414 15019 5	9003414 19019 1	9003414 17019 3
	A2	180 x 260 x 218	172 x 212 x 209	177 x 217	186,9	9003414 15029 4	9003414 19029 0	9003414 17029 2
	A3	180 x 300 x 217	172 x 252 x 209	177 x 257	202,4	9003414 15039 3	9003414 19039 9	9003414 17039 1
	A4	180 x 380 x 222	172 x 332 x 209	177 x 337	247,0	9003414 15049 2	9003414 19049 8	9003414 17049 0
	A5	260 x 220 x 218	252 x 172 x 209	257 x 177	203,4	9003414 15059 1	9003414 19059 7	9003414 17059 9
	A6	260 x 260 x 218	252 x 212 x 209	257 x 217	226,9	9003414 15069 0	9003414 19069 6	9003414 17069 8
A7	260 x 300 x 217	252 x 252 x 209	257 x 257	243,2	9003414 15079 9	9003414 19079 5	9003414 17079 7	
A8	260 x 380 x 222	252 x 332 x 209	257 x 337	293,9	9003414 15089 8	9003414 19089 4	9003414 17089 6	

AvantGarde®ECO	Size	Exterior Dimensions*	Interior Dimensions	Foundation Dimensions	Weight	EAN Code		
		W x L x H (cm)	W x L x H (cm)	W x L (cm)	(kg)	Metallic Silver	Metallic Quartz Grey	Metallic Dark Grey
	With standard door, door opening: 76 x 182 cm (W x H), right door hinge							
	A1	180 x 220 x 218	172 x 172 x 209	177 x 177	144,9	9003414 15610 4	9003414 19610 0	9003414 17610 2
	A2	180 x 260 x 218	172 x 212 x 209	177 x 217	164,8	9003414 15620 3	9003414 19620 9	9003414 17620 1
	A3	180 x 300 x 217	172 x 252 x 209	177 x 257	183,2	9003414 15630 2	9003414 19630 8	9003414 17630 0
	A4	180 x 380 x 222	172 x 332 x 209	177 x 337	226,3	9003414 15640 1	9003414 19640 7	9003414 17640 9
	A5	260 x 220 x 218	252 x 172 x 209	257 x 177	180,1	9003414 15650 0	9003414 19650 6	9003414 17650 8
	A6	260 x 260 x 218	252 x 212 x 209	257 x 217	203,6	9003414 15660 9	9003414 19660 5	9003414 17660 7
	A7	260 x 300 x 217	252 x 252 x 209	257 x 257	219,9	9003414 15670 8	9003414 19670 4	9003414 17670 6
	A8	260 x 380 x 222	252 x 332 x 209	257 x 337	270,6	9003414 15680 7	9003414 19680 3	9003414 17680 5
	With double door, door opening: A1 - A4: 139 x 182 cm (W x H), A5 - A8: 155 x 182 cm (W x H)							
	A1	180 x 220 x 218	172 x 172 x 209	177 x 177	151,7	9003414 15619 7	9003414 19619 3	9003414 17619 5
	A2	180 x 260 x 218	172 x 212 x 209	177 x 217	171,6	9003414 15629 6	9003414 19629 2	9003414 17629 4
	A3	180 x 300 x 217	172 x 252 x 209	177 x 257	187,1	9003414 15639 5	9003414 19639 1	9003414 17639 3
	A4	180 x 380 x 222	172 x 332 x 209	177 x 337	231,7	9003414 15649 4	9003414 19649 0	9003414 17649 2
	A5	260 x 220 x 218	252 x 172 x 209	257 x 177	185,7	9003414 15659 3	9003414 19659 9	9003414 17659 1
	A6	260 x 260 x 218	252 x 212 x 209	257 x 217	209,2	9003414 15669 2	9003414 19669 8	9003414 17669 0
A7	260 x 300 x 217	252 x 252 x 209	257 x 257	225,5	9003414 15679 1	9003414 19679 7	9003414 17679 9	
A8	260 x 380 x 222	252 x 332 x 209	257 x 337	276,2	9003414 15689 0	9003414 19689 6	9003414 17689 8	

Additions		Side canopy size L for garden shed AvantGarde® und AvantGarde®ECO, width: 240 cm						
	A1, A5	243 x 220 x 218	233 x 168 x 194	238 x 173	77,1	9003414 15056 0	9003414 19056 6	9003414 17056 8
	A2, A6	243 x 260 x 218	233 x 207 x 194	238 x 212	87,5	9003414 15066 9	9003414 19066 5	9003414 17066 7
	A3, A7	243 x 300 x 218	233 x 248 x 194	238 x 253	99,2	9003414 15076 8	9003414 19076 4	9003414 17076 6
	A4, A8	243 x 340 x 222	233 x 288 x 194	238 x 293	119,2	9003414 15086 7	9003414 19086 3	9003414 17086 5
Side wall for side canopy								
	A1, A5	157 x 2,9 x 182			37,7	9003414 15058 4	9003414 19058 0	9003414 17058 2
	A2, A6	197 x 2,9 x 182			45,5	9003414 15068 3	9003414 19068 9	9003414 17068 1
	A3, A7	238 x 2,9 x 182			54,7	9003414 15078 2	9003414 19078 8	9003414 17078 0
	A4, A8	318 x 2,9 x 182			73,5	9003414 15088 1	9003414 19088 7	9003414 17088 9
Back wall for side canopy: width: 240 cm								
	L	231,5 x 3,5 x 182			52,7	9003414 15097 3	9003414 19097 9	9003414 17097 1

Panorama®	Size	Exterior Dimensions*	Interior Dimensions	Foundation Dimensions	Weight	EAN Code		
		W x L x H (cm)	W x L x H (cm)	W x L (cm)	(kg)	Metallic Silver	Metallic Quartz Grey	Metallic Dark Grey
	With standard door, door opening: 76 x 182 cm (W x H), right door hinge							
	P1	273 x 158 x 227	252 x 132 x 220	257 x 137	202,2	9003414 13020 3	9003414 18020 8	9003414 14020 2
	P2	273 x 198 x 227	252 x 172 x 220	257 x 177	225,7	9003414 13030 2	9003414 18030 7	9003414 14030 1
	P3	273 x 238 x 227	252 x 212 x 220	257 x 217	250,0	9003414 13040 1	9003414 18040 6	9003414 14040 0
	P4	273 x 278 x 227	252 x 252 x 220	257 x 257	271,9	9003414 13050 0	9003414 18050 5	9003414 14050 9
	P5	273 x 318 x 227	252 x 292 x 220	257 x 297	293,9	9003414 13060 9	9003414 18060 4	9003414 14060 8
	With double door, door opening: 155 x 182 cm (W x H)							
	P1	273 x 158 x 227	252 x 132 x 220	257 x 137	214,6	9003414 13029 6	9003414 18029 1	9003414 14029 5
	P2	273 x 198 x 227	252 x 172 x 220	257 x 177	238,1	9003414 13039 5	9003414 18039 0	9003414 14039 4
	P3	273 x 238 x 227	252 x 212 x 220	257 x 217	262,4	9003414 13049 4	9003414 18049 9	9003414 14049 3
P4	273 x 278 x 227	252 x 252 x 220	257 x 257	284,3	9003414 13059 3	9003414 18059 8	9003414 14059 2	
P5	273 x 318 x 227	252 x 292 x 220	257 x 297	306,3	9003414 13069 2	9003414 18069 7	9003414 14069 1	

\*highest point, incl. roof overhang

Accessories HighLine®, Panorama®, AvantGarde®, AvantGarde®ECO		Dimensions W x L x H (cm) / Colour				
Accessories in matching colour			HighLine®	Panorama®	AvantGarde®	AvantGarde®ECO
Window unit		Metallic Silver	9003414 43065 5	9003414 43065 5	9003414 43065 5	9003414 43065 5
		Metallic Quartz Grey	9003414 43085 3	9003414 43085 3	9003414 43085 3	9003414 43085 3
		Metallic Dark Grey	9003414 43055 6	9003414 43055 6	9003414 43055 6	9003414 43055 6
Rainwater Downpipe Set		Metallic Silver	9003414 44025 8	9003414 44024 1	9003414 44022 7	9003414 44022 7
		Metallic Quartz Grey	9003414 44085 2	9003414 44084 5	9003414 44082 1	9003414 44082 1
		Metallic Dark Grey	9003414 44065 4	9003414 44064 7	9003414 44062 3	9003414 44062 3
FloraBoard		Metallic Silver	9003414 47030 9	9003414 47030 9	9003414 47030 9	9003414 47030 9
		Metallic Quartz Grey	9003414 47080 4	9003414 47080 4	9003414 47080 4	9003414 47080 4
		Metallic Dark Grey	9003414 47050 7	9003414 47050 7	9003414 47050 7	9003414 47050 7
Tool Holder	2 pieces per package	Metallic Silver	9003414 47031 6	9003414 47031 6	9003414 47031 6	
		Metallic Quartz Grey	9003414 47081 1	9003414 47081 1	9003414 47081 1	
		Metallic Dark Grey	9003414 47051 4	9003414 47051 4	9003414 47051 4	
Tool Holder ECO	2 pieces per package Compatible with ECO doors	Metallic Silver				9003414 47032 3
		Metallic Quartz Grey				9003414 47082 8
		Metallic Dark Grey				9003414 47052 1
Made from hot-dip galvanised, polyamide coated steel plate						
Shelf Support Rails	2 pieces per package	4 x 4 x 185	9003414 46021 8	9003414 46021 8	9003414 46021 8	9003414 46021 8
Shelves	2 pieces per package	72 x 25,5 x 7,5	9003414 45010 3	9003414 45010 3	9003414 45010 3	9003414 45010 3
	4 pieces per package	72 x 24,5 x 7,5	9003414 45020 2	9003414 45020 2	9003414 45020 2	9003414 45020 2
	2 pieces per package	72 x 43,5 x 12,5	9003414 45030 1	9003414 45030 1	9003414 45030 1	9003414 45030 1
Folding Table		69,2 x 57,5 x 40	9003414 40011 5	9003414 40011 5	9003414 40011 5	9003414 40011 5
Suspension Basket	With wall bracket	67 x 34 x 20	9003414 47071 2	9003414 47071 2	9003414 47071 2	9003414 47071 2
Bin Bag Holder		72 x 44,6 x 16,2	9003414 45016 5	9003414 45016 5	9003414 45016 5	9003414 45016 5
Hook Set	One combi, handle and shovel hook each	72 x 17 x 73	9003414 47070 5	9003414 47070 5	9003414 47070 5	9003414 47070 5
Tool Hangers	4 pieces per package	13 x 9,5 x 30	9003414 47020 0	9003414 47020 0	9003414 47020 0	9003414 47020 0
Door Baskets	2 pieces per package	34 x 10 x 9,5	9003414 46025 6	9003414 46025 6	9003414 46025 6	9003414 46025 6
Shelf Baskets	2 pieces per package	72 x 16 x 11	9003414 46026 3	9003414 46026 3	9003414 46026 3	9003414 46026 3
Threshold Access Ramp	Only with double door and floor frame	135 x 14,5 x 7	9003414 41000 8	9003414 41000 8	9003414 41000 8	9003414 41000 8
BikeLift®	Standard	16,9 x 43,1 x 185,4	9003414 49050 5	9003414 49050 5	9003414 49050 5	9003414 49050 5
	With swivel mount	16,9 x 57,4 x 184,6	9003414 49051 2	9003414 49051 2	9003414 49051 2	9003414 49051 2
Bicycle Hanger BikeMax	1 piece per package	6 x 14,5 x 185	9003414 49011 6	9003414 49011 6	9003414 49011 6	9003414 49011 6
	2 pieces per package		9003414 49021 5	9003414 49021 5	9003414 49021 5	9003414 49021 5
BikeHolder	Set for 3 bikes	72 x 10 x 33	9003414 49012 3	9003414 49012 3	9003414 49012 3	9003414 49012 3
Electric Mounting Panel		28 x 6 x 190	9003414 46031 7	9003414 46031 7	9003414 46031 7	9003414 46031 7
Solar Light		15 x 10 x 5	9003414 46042 3	9003414 46042 3	9003414 46042 3	9003414 46042 3
LED Light		44 x 4 x 1,5	9003414 46041 6	9003414 46041 6	9003414 46041 6	9003414 46041 6
PV Mounting Preparation for Side Canopy	With 3 vertical wall rails	3 x 3,5 x 187	9003414 47023 1	9003414 47023 1	9003414 47023 1	9003414 47023 1
Gas springs are standard in the basic equipment! Exceptions: AvantGarde®ECO and additional door ECO						
Gas Spring Set	1 piece per package	34 x 2 x 2				9003414 83608 2
Compatible with ECO doors	2 pieces per package	34 x 2 x 2				9003414 83609 9
Foundation Accessories / Foundations		EAN Code	EAN Code	EAN Code	EAN Code	EAN Code
suitable for		Aluminium Floor Frame	Aluminium Floor Panels	SmartBase	SmartBase <sup>PLUS</sup>	
HighLine®	Panorama®					
		AvantGarde® AvantGarde®ECO				
		A1	9003414 41031 2	9003414 48031 5	9003414 43946 7	9003414 43446 2
		A2	9003414 41071 8	9003414 48071 1	9003414 43988 7	9003414 43488 2
H1, H5	P1		9003414 41022 0	9003414 48022 3	9003414 43952 8	9003414 43452 3
H2	P2	A3, A5	9003414 41041 1	9003414 48041 4	9003414 43958 0	9003414 43458 5
		A4	9003414 41081 7	9003414 48081 0	9003414 43976 4	9003414 43476 9
H3	P3	A6	9003414 41042 8	9003414 48042 1	9003414 43963 4	9003414 43463 9
H4	P4	A7	9003414 41051 0	9003414 48051 3	9003414 43968 9	9003414 43468 4
H5	P5		9003414 41062 6	9003414 48062 9	9003414 43973 3	9003414 43473 8
		A8	9003414 41061 9	9003414 48061 2	9003414 43978 8	9003414 43478 3
H6			9003414 41043 5	9003414 48043 8	9003414 43995 5	9003414 43495 0
Note: Hammer drills can be rented from any well-equipped specialist, however the drill bit required is available from Biohört.						
Drill Bit Ø 40 x 570 mm for SDS-MAX chuck Ø 18 mm (for SmartBase <sup>PLUS</sup> )						9003414 43410 3
Note: In combination with an additional door, an additional package is required for the SmartBase and SmartBase <sup>PLUS</sup> .						
Foundation Additional Package				9003414 43505 6	9003414 43405 9	
Note: If the floor frame is laid directly on a gravel base (approx. 10 cm gravel, without foundation or slabs), ground anchors are required for securing to the ground. Storm resistance must be ensured by the customer. For size A1, H5, H1, P1: 8 pcs. in total; for size H2, P2, A2, H3, P3, A3, A4, A5, A6: 10 pcs. in total; for size H4, P4, H5, P5, H6 A7, A8: 12 pcs. in total are necessary.						
Ground Anchor	4 pieces per package	9003414 41004 6				
	6 pieces per package	9003414 41006 0				



## CasaNova® – Your High Quality Utility Room

Thanks to the modular construction, there are no limits to your wishes. Doors and windows can be positioned freely according to your expectations. More information at [www.biohort.com/casanova](http://www.biohort.com/casanova).

Product Info



Neo	Size	Exterior Dimensions*	Interior Dimensions	Foundation Dimensions	Weight (kg)	EAN Code		
		W x L x H (cm)	W x L x H (cm)	W x L (cm)		Metallic Silver	Metallic Quartz Grey	Metallic Dark Grey
With standard door, door opening: 83 x 200 cm (W x H), right door hinge								
	1A	180 x 180 x 222	164 x 164 x 208	173 x 173	211,5	9003414 81003 7	9003414 87003 1	9003414 85003 3
	2A	180 x 236 x 222	164 x 220 x 208	173 x 229	243,7	9003414 81006 8	9003414 87006 2	9003414 85006 4
	3A	180 x 292 x 222	164 x 276 x 208	173 x 285	304,4	9003414 81009 9	9003414 87009 3	9003414 85009 5
	4A	180 x 348 x 222	164 x 332 x 208	173 x 341	335,8	9003414 81014 3	9003414 87014 7	9003414 85014 9
	1B	236 x 180 x 222	220 x 164 x 208	229 x 173	245,9	9003414 81029 7	9003414 87029 1	9003414 85029 3
	2B	236 x 236 x 222	220 x 220 x 208	229 x 229	284,7	9003414 81034 1	9003414 87034 5	9003414 85034 7
	3B	236 x 292 x 222	220 x 276 x 208	229 x 285	349,2	9003414 81040 2	9003414 87040 6	9003414 85040 8
	4B	236 x 348 x 222	220 x 332 x 208	229 x 341	392,9	9003414 81044 0	9003414 87044 4	9003414 85044 6
	1C	292 x 180 x 222	276 x 164 x 208	285 x 173	311,9	9003414 81082 2	9003414 87082 6	9003414 85082 8
	2C	292 x 236 x 222	276 x 220 x 208	285 x 229	348,7	9003414 81085 3	9003414 87085 7	9003414 85085 9
	3C	292 x 292 x 222	276 x 276 x 208	285 x 285	433,9	9003414 81089 1	9003414 87089 5	09003414850897
	4C	292 x 348 x 222	276 x 332 x 208	285 x 341	474,7	9003414 81092 1	9003414 87092 5	9003414 85092 7
	1D	348 x 180 x 222	332 x 164 x 208	341 x 173	340,1	9003414 82024 1	9003414 89024 4	9003414 86024 7
	2D	348 x 236 x 222	332 x 220 x 208	341 x 229	383,5	9003414 82028 9	9003414 89028 2	9003414 86028 5
	3D	348 x 292 x 222	332 x 276 x 208	341 x 285	468,6	9003414 82031 9	9003414 89031 2	9003414 86031 5
	4D	348 x 348 x 222	332 x 332 x 208	341 x 341	515,0	9003414 82034 0	9003414 89034 3	9003414 86034 6
With double door, door opening: 167 x 200 cm (W x H)								
	1B	236 x 180 x 222	220 x 164 x 208	229 x 173	257,6	9003414 81060 0	9003414 87060 4	9003414 85060 6
	2B	236 x 236 x 222	220 x 220 x 208	229 x 229	296,7	9003414 81063 1	9003414 87063 5	9003414 85063 7
	3B	236 x 292 x 222	220 x 276 x 208	229 x 285	361,0	9003414 81069 3	9003414 87069 7	9003414 85069 9
	4B	236 x 348 x 222	220 x 332 x 208	229 x 341	399,9	9003414 81072 3	9003414 87072 7	9003414 85072 9
	1C	292 x 180 x 222	276 x 164 x 208	285 x 173	323,9	9003414 82005 0	9003414 89005 3	9003414 86005 6
	2C	292 x 236 x 222	276 x 220 x 208	285 x 229	360,5	9003414 82008 1	9003414 89008 4	9003414 86008 7
	3C	292 x 292 x 222	276 x 276 x 208	285 x 285	440,9	9003414 82011 1	9003414 89011 4	9003414 86011 7
	4C	292 x 348 x 222	276 x 332 x 208	285 x 341	485,5	9003414 82014 2	9003414 89014 5	9003414 86014 8
	1D	348 x 180 x 222	332 x 164 x 208	341 x 173	351,9	9003414 82044 9	9003414 89044 2	9003414 86044 5
	2D	348 x 236 x 222	332 x 220 x 208	341 x 229	390,5	9003414 82048 7	9003414 89048 0	9003414 86048 3
	3D	348 x 292 x 222	332 x 276 x 208	341 x 285	479,4	9003414 82051 7	9003414 89051 0	9003414 86051 3
	4D	348 x 348 x 222	332 x 332 x 208	341 x 341	526,7	9003414 82054 8	9003414 89054 1	9003414 86054 4
<b>Additions</b>								
Side canopy for Neo garden shed								
	2A-2D	300 x 235 x 220			226,8	9003414 81026 6	9003414 87026 0	9003414 85026 2
	3A-3D	300 x 291 x 220			287,3	9003414 81036 5	9003414 87036 9	9003414 85036 1
	4A-4D	300 x 347 x 220			319,3	9003414 81046 4	9003414 87046 8	9003414 85046 0
Side wall for side canopy								
	2A-2D	203 x 4,3 x 200			65,5	9003414 81028 0	9003414 87028 4	9003414 85028 6
	3A-3D	259 x 4,3 x 200			72,2	9003414 81038 9	9003414 87038 3	9003414 85038 5
	4A-4D	315 x 4,3 x 200			89,7	9003414 81048 8	9003414 87048 2	9003414 85048 4
Back wall for side canopy								
	2A-4D	299 x 4,3 x 200			88,6	9003414 81098 3	9003414 87098 7	9003414 85098 9
Tinted glass panel for side canopy								
	2A-4D	31,8 x 4,2 x 200			11,6	9003414 47934 0	9003414 47984 5	9003414 47954 8
FloraBoard for side canopy								
	2A-4D	84,1 x 25 x 197,2			11,9	9003414 47036 1	9003414 47086 6	9003414 47056 9

\*highest point, incl. roof overhang

Foundation Accessories / Foundation	EAN Code	EAN Code	EAN Code	EAN Code
suitable for Neo	Aluminium Floor Frame	Aluminium Floor Panels	SmartBase	SmartBase <sup>PLUS</sup>
1A	9003414 41014 5	9003414 48014 8	9003414 43950 4	9003414 43450 9
1B, 2A	9003414 41024 4	9003414 48024 7	9003414 43954 2	9003414 43454 7
1C, 3A	9003414 41034 3	9003414 48034 6	9003414 43955 9	9003414 43455 4
1D, 4A	9003414 41044 2	9003414 48044 5	9003414 43956 6	9003414 43456 1
2B	9003414 41040 4	9003414 48040 7	9003414 43918 4	9003414 43418 9
2C, 3B	9003414 41054 1	9003414 48054 4	9003414 43960 3	9003414 43460 8
2D, 4B	9003414 41067 1	9003414 48064 3	9003414 43962 7	9003414 43462 2
3C	9003414 41074 9	9003414 48074 2	9003414 43965 8	9003414 43465 3
3D, 4C	9003414 41084 8	9003414 48084 1	9003414 43970 2	9003414 43470 7
4D	9003414 41094 7	9003414 48094 0	9003414 43974 0	9003414 43474 5

Note: Hammer drills can be rented from any well-equipped specialist, however the drill bit required is available from Biohort.

Drill Bit Ø 40 x 570 mm for SDS-MAX chuck Ø 18 mm (for SmartBase<sup>PLUS</sup>)

9003414 43410 3

Note: In combination with an additional door, an additional package is required for the SmartBase and SmartBase<sup>PLUS</sup>.

Foundation Additional Package

9003414 43505 6

9003414 43405 9

Note: If the floor frame is laid directly on a gravel base (approx. 10 cm gravel, without foundation or slabs), ground anchors are required for securing to the ground. Storm resistance must be ensured by the customer. For size 1A, 1B, 2A, 2B: 8 pcs. in total; for size 1C, 3A, 1D, 4A: 10 pcs. in total; for size 2C, 3B, 2D, 4B: 14 pcs. in total; for size 3C, 3D, 4C, 4D: 16 pcs. in total are necessary.









Ground Anchor	4 pieces per package	9003414 41004 6
	6 pieces per package	9003414 41006 0

Interior Fittings		EAN Code	EAN Code
suitable for		Interior Panelling	Insulation
Standard door	Double door		
1A		9003414 46051 5	9003414 46081 2
1B, 2A		9003414 46052 2	9003414 46082 9
	1B	9003414 46053 9	9003414 46081 2
1C, 3A		9003414 46056 0	9003414 46084 3
	1C	9003414 46057 7	9003414 46082 9
1D, 4A		9003414 46058 4	9003414 46086 7
	1D	9003414 46061 4	9003414 46084 3
2B		9003414 46054 6	9003414 46084 3
	2B	9003414 46055 3	9003414 46082 9
2C, 3B		9003414 46059 1	9003414 46086 7
	2C, 3B	9003414 46060 7	9003414 46084 3
2D, 4B		9003414 46062 1	9003414 46088 1
	2D, 4B	9003414 46064 5	9003414 46086 7
3C		9003414 46063 8	9003414 46088 1
	3C	9003414 46065 2	9003414 46086 7
3D, 4C		9003414 46066 9	9003414 46090 4
	3D, 4C	9003414 46067 6	9003414 46088 1
4D		9003414 46068 3	9003414 46093 5
	4D	9003414 46069 0	9003414 46090 4

Accessories		Dimensions W x L x H (cm)	EAN Code		
Accessories in matching colour			Metallic Silver	Metallic Quartz Grey	Metallic Dark Grey
Glass Panel	tinted	32 x 3,3 x 207	9003414 47034 7	9003414 47084 2	9003414 47054 5
Tool Holder	2 pieces per package	30 x 5 x 3,5	9003414 47032 3	9003414 47082 8	9003414 47052 1
FloraBoard		84 x 24 x 205	9003414 47035 4	9003414 47085 9	9003414 47055 2

Accessories		Dimensions W x L x H (cm)	EAN Code
Accessories made of galvanised steel, grey white coated			
Shelves	2 pieces per package	56 x 26 x 17,3	9003414 45040 0
	4 pieces per package	56 x 26 x 17,3	9003414 45050 9
	2 pieces per package	56 x 44,5 x 17,3	9003414 45060 8
Suspension Basket	With wall bracket	56 x 34 x 20	9003414 47073 6
Bin Bag Holder		56 x 44,6 x 21,2	9003414 45046 2
Hook Set	One combi, handle and shovel hook each	56 x 23 x 10	9003414 47072 9
Tool Hangers	2 pieces per package	28 x 10,4 x 17,2	9003414 47021 7
Door Baskets	2 pieces per package	34 x 10 x 9,5	9003414 46025 6
Shelf Baskets	2 pieces per package	72 x 16 x 11	9003414 46026 3
Threshold Access Ramp	Only with double door and floor frame	170,5 x 9,1 x 3	9003414 41001 5
BikeLift*	Standard	28,2 x 41,3 x 184,7	9003414 49052 9
	With swivel mount	28,2 x 55,6 x 182,8	9003414 49053 6
Bicycle Hanger BikeMax	1 piece per package	28 x 14,5 x 205,5	9003414 49030 7
BikeHolder	Set for 2 bikes	56 x 17,7 x 33	9003414 49032 1
Electric Mounting Panel		28 x 4 x 204	9003414 46034 8
Solar Light		15 x 10 x 5	9003414 46042 3
LED Light		44 x 4 x 1,5	9003414 46041 6
PV Mounting Preparation for Side Wall	With 3 vertical wall rails	4,5 x 3,5 x 206	9003414 47024 8

## Special Solutions

Door Variants for HighLine®, Panorama® and AvantGarde® Garden Sheds	Door Opening	EAN Code			
	W x H (cm)	Metallic Silver	Metallic Quartz Grey	Metallic Dark Grey	
Surcharge for Standard Door with Left Door Hinge		(not available for double doors), please note on the order "left door hinge"			
	76 x 182	9003414 <b>890015</b>	9003414 <b>890015</b>	9003414 <b>890015</b>	
Additional door		With stainless steel door handle and gas spring			
	79x 185	9003414 <b>830028</b>	9003414 <b>880023</b>	9003414 <b>840027</b>	
Additional door double		(not for AvantGarde®)			
	155 x 182	9003414 <b>830042</b>	9003414 <b>880047</b>	9003414 <b>840041</b>	
Door Variants for AvantGarde®ECO Garden Shed	Door Opening	EAN Code			
	W x H (cm)	Metallic Silver	Metallic Quartz Grey	Metallic Dark Grey	
Additional door		Corrugated, with T-handle cylinder lock and door hooks			
	79 x 185	9003414 <b>836020</b>	9003414 <b>886025</b>	9003414 <b>846029</b>	
Side canopy for Europa Garden Shed	Door Opening	EAN Code			
	W x H (cm)	Metallic Silver	Metallic Quartz Grey	Metallic Dark Grey	Dark Green
Additional door double		Corrugated, with T-handle cylinder lock and door hooks			
	148 x 172	9003414 <b>290013</b>	9003414 <b>220010</b>	9003414 <b>240018</b>	9003414 <b>230019</b>
Side canopy for Neo Garden Shed	Door Opening	EAN Code			
	W x H (cm)	Metallic Silver	Metallic Quartz Grey	Metallic Dark Grey	
Additional door					
	83 x 203	9003414 <b>810020</b>	9003414 <b>870024</b>	9003414 <b>850026</b>	
Additional door double					
	167 x 200	9003414 <b>810013</b>	9003414 <b>870017</b>	9003414 <b>850019</b>	
Special Solution SmartBase <sup>PLUS</sup>			EAN Code		
Extension					
	For ground screw extension tube with screw, washer and nut. Max. extension approx. 500 mm	1 piece per package	9003414 <b>434110</b>		

## Outdoor Lockers

WoodStock®	Size	Exterior Dimensions*	Interior Dimensions	Foundation Dimensions	Volume (m³)	Weight (kg)	EAN Code		
		W x L x H (cm)	W x L x H (cm)	W x L (cm)			Metallic Silver	Metallic Quartz Grey	Metallic Dark Grey
	150	157 x 102 x 199	142 x 70 x 185	155 x 83	1,8	48,5	9003414 35010 6	9003414 38010 3	9003414 37010 4
	230	229 x 102 x 199	214 x 70 x 185	227 x 83	2,8	54,1	9003414 35020 5	9003414 38020 2	9003414 37020 3
	300	300,7 x 102 x 199	286 x 70 x 185	299 x 83	3,7	67,0	9003414 35040 3	9003414 38040 0	9003414 37040 1
Accessories		For Size Dimensions W x L x H (cm)							
Aluminium Floor Panels	150	141,5 x 69,5 x 0,2				9,9	9003414 48010 0		
	230	213,5 x 69,5 x 0,2				14,0	9003414 48080 3		
	300	285,5 x 69,5 x 0,2				15,3	9003414 48013 1		
Back Wall	150	145,5 x 1,1 x 196,5				15,7	9003414 35012 0	9003414 38012 7	9003414 37012 8
	230	217,5 x 1,1 x 196,5				22,5	9003414 35022 9	9003414 38022 6	9003414 37022 7
	300	288,6 x 1,1 x 196,5				28,7	9003414 35042 7	9003414 38042 4	9003414 37042 5
Door Package	150	157 x 5 x 171				28,5	9003414 35001 4	9003414 38001 1	9003414 37001 2
	230	229 x 5 x 171				29	9003414 35002 1	9003414 38002 8	9003414 37002 9
Note: If the floor frame is laid directly on a gravel base (approx. 10 cm gravel, without foundation or slabs), ground anchors are required for securing to the ground. Storm resistance must be ensured by the customer. For sizes 150, 230: 6 pcs. in total; for size 300: 10 pcs. in total are necessary.									
Ground Anchor	4 pieces per package						9003414 41004 6		
	6 pieces per package						9003414 41006 0		

\*highest point, incl. roof overhang

Equipment Locker	Size	Exterior Dimensions*	Interior Dimensions	Foundation Dimensions	Weight (kg)	EAN Code			
		W x L x H (cm)	W x L x H (cm)	W x L (cm)		Metallic Silver	Metallic Quartz Grey	Metallic Dark Grey	
	Door opening: Size 90: 65 x 170 cm (W x H), size 150: 135 x 170 cm (W x H)								
	90	93 x 83 x 182,5	88 x 78 x 177	93 x 83	56,4	9003414 34030 5	9003414 30030 9	9003414 31030 8	
	150	155 x 83 x 182,5	150 x 78 x 177	155 x 83	75,1	9003414 34010 7	9003414 30010 1	9003414 31010 0	
	150 <sup>LARGE</sup>	156 x 155 x 184	150 x 150 x 177	155 x 155	106,1	9003414 34910 0	9003414 30910 4	9003414 31910 3	
	190	190 x 83 x 182,5	185 x 78 x 177	190 x 83	87,9	9003414 34060 2	9003414 30060 6	9003414 31060 5	
	190 <sup>LARGE</sup>	192 x 155 x 184	186 x 150 x 177	191 x 155	119,2	9003414 34960 5	9003414 30960 9	9003414 31960 8	
	230	227 x 83 x 182,5	222 x 78 x 177	227 x 83	96,2	9003414 34080 0	9003414 30080 4	9003414 31080 3	
	230 <sup>LARGE</sup>	228 x 155 x 184	222 x 150 x 177	227 x 155	130,5	9003414 34980 3	9003414 30980 7	9003414 31980 6	

\*highest point, incl. roof overhang

Foundation Accessories / Foundations Equipment Locker	Aluminium Floor Frame	Aluminium Floor Panels	SmartBase	SmartBase <sup>PLUS</sup>
	90	9003414 41011 4	9003414 48011 7	9003414 43982 5
150	9003414 41010 7	9003414 48010 0	9003414 43901 6	9003414 43401 1
150 <sup>LARGE</sup>	9003414 41020 6	9003414 48020 9	9003414 43906 1	9003414 43406 6
190	9003414 41012 1	9003414 48012 4	9003414 43929 0	9003414 43426 4
190 <sup>LARGE</sup>	9003414 41015 2	9003414 48015 5	9003414 43910 8	9003414 43510 0
230	9003414 41080 0	9003414 48080 3	9003414 43936 8	9003414 43436 3
230 <sup>LARGE</sup>	9003414 41030 5	9003414 48030 8	9003414 43912 2	9003414 43412 7

Note: Hammer drills can be rented from any well-equipped specialist, however the drill bit required is available from Biohort.

Drill Bit Ø 40 x 570 mm for SDS-MAX chuck Ø 18 mm (for SmartBase <sup>PLUS</sup> )	9003414 43410 3
--	-----------------

Note: If the floor frame is laid directly on a gravel base (approx. 10 cm gravel, without foundation or slabs), ground anchors are required for securing to the ground. Storm resistance must be ensured by the customer. For sizes 90, 150: 4 pcs. in total; for sizes 150<sup>LARGE</sup>, 190, 190<sup>LARGE</sup>, 230: 6 pcs. in total; for sizes 230<sup>LARGE</sup>: 8 pcs. in total

Ground Anchor	4 pieces per package	9003414 41004 6
	6 pieces per package	9003414 41006 0

Accessories	Dimensions W x L x H (cm)		EAN Code
Shelf Support Rails	2 pieces per package	4 x 4 x 173	9003414 46020 1
	2 pieces per package	72 x 25,5 x 7,5	9003414 45010 3
Shelves	4 pieces per package	72 x 24,5 x 7,5	9003414 45020 2
	2 pieces per package	72 x 43,5 x 12,5	9003414 45030 1
Folding Table		69,2 x 57,5 x 40	9003414 40011 5
Suspension Basket	With wall bracket	67 x 34 x 20	9003414 47071 2
Bin Bag Holder		72 x 44,6 x 16,2	9003414 45016 5
Hook Set	One combi, handle and shovel hook each	72 x 17 x 73	9003414 47070 5
Tool Hangers	4 pieces per package	13 x 9,5 x 30	9003414 47020 0
Door Baskets	2 pieces per package	34 x 10 x 9,5	9003414 46025 6
Shelf Baskets	2 pieces per package	72 x 16 x 11	9003414 46026 3
Electric Mounting Panel		28 x 6 x 172,5	9003414 46030 0
Solar Light		15 x 10 x 5	9003414 46042 3
LED Light		44 x 4 x 1,5	9003414 46041 6
Gas Spring Set	150 / 230 / 150 <sup>LARGE</sup> / 230 <sup>LARGE</sup>	170 x 13,5 x 9,5	9003414 40008 5
	190 / 190 <sup>LARGE</sup>	170 x 13,5 x 9,5	9003414 40009 2

Julia® Patio Locker	Size	Exterior Dimensions	Interior Dimensions	Volume	Weight	EAN Code		
		W x L x H (cm)	W x L x H (cm)	(L)	(kg)	Metallic Silver	Metallic Quartz Grey	Metallic Dark Grey
	<b>M</b>	77,7 x 57 x 140,2	72,1 x 45,9 x 135,3	447,8	40,7	9003414 55075 9	9003414 58075 6	9003414 56075 8
	<b>L</b>	77,7 x 87 x 140,2	72,1 x 76 x 135,3	741,4	49,3	9003414 55085 8	9003414 58085 5	9003414 56085 7
	<b>M<sup>HIGH</sup></b>	77,7 x 57 x 180,9	72,1 x 45,9 x 176	582,5	47,3	9003414 55015 5	9003414 58015 2	9003414 56015 4
	<b>L<sup>HIGH</sup></b>	77,7 x 87 x 180,9	72,1 x 76 x 176	964,4	56,9	9003414 55025 4	9003414 58025 1	9003414 56025 3
Accessories		For Size	Dimensions W x L x H (cm)		EAN Code			
Shelf Set		<b>for all sizes</b>	66 x 28 x 7,5		9003414 75056 2			
Full-sized Shelf		<b>L, L<sup>HIGH</sup></b>	66 x 74 x 12,5		9003414 75057 9			

Romeo® Patio Locker	Size	Exterior Dimensions	Interior Dimensions	Volume	Weight	EAN Code		
		W x L x H (cm)	W x L x H (cm)	(L)	(kg)	Metallic Silver	Metallic Quartz Grey	Metallic Dark Grey
	<b>M</b>	132 x 57 x 140,2	127 x 46 x 135	788,7	68,1	9003414 55070 4	9003414 58070 1	9003414 56070 3
	<b>L</b>	132 x 87 x 140,2	127 x 76 x 135	1.303,0	81,9	9003414 55080 3	9003414 58080 0	9003414 56080 2
	<b>M<sup>HIGH</sup></b>	132 x 57 x 181	127 x 46 x 176	1.028,2	76,8	9003414 55010 0	9003414 58010 7	9003414 56010 9
	<b>L<sup>HIGH</sup></b>	132 x 87 x 181	127 x 76 x 176	1.698,8	90,4	9003414 55020 9	9003414 58020 6	9003414 56020 8
Accessories		For Size	Dimensions W x L x H (cm)		EAN Code			
Shelves		<b>for all sizes</b>	61 x 43 x 40 (2-part)		9003414 75055 5			

## Outdoor Boxes, Wheelie Bin Boxes and Bike Storage

LeisureTime Box	Size	Exterior Dimensions	Interior Dimensions	Volume	Weight	EAN Code				
		W x L x H (cm)	W x L x H (cm)	(L)	(kg)	White	Metallic Silver	Met. Quartz Grey	Met. Dark Grey	Metallic Bronze
	<b>100</b>	101 x 46 x 61	92 x 37,5 x 56	193,2	19,4	9003414 61010 1	9003414 64010 8	9003414 68010 4	9003414 65010 7	9003414 62010 0
	<b>130</b>	134 x 62 x 71	125 x 53,5 x 66	441,4	29,6	9003414 61040 8	9003414 64040 5	9003414 68040 1	9003414 65040 4	9003414 62040 7
	<b>160<sup>HIGH</sup></b>	160 x 79 x 83	151 x 70,5 x 78	830,4	43,4	9003414 61060 6	9003414 64060 3	9003414 68060 9	9003414 65060 2	9003414 62060 5
	<b>180</b>	181 x 79 x 71	172 x 70,5 x 66	800,3	45,6	9003414 61030 9	9003414 64030 6	9003414 68030 2	9003414 65030 5	9003414 62030 8
	<b>200</b>	201 x 79 x 83	192 x 70,5 x 77,5	1.049,0	56,0	9003414 61090 3	9003414 64090 0	9003414 68090 6	9003414 65090 9	9003414 62090 2
Accessories		For Size	Dimensions (cm)		EAN Code					
Lid Storage Net		<b>for all sizes</b>	25 x 67 x 2		9003414 67010 5					
Suspension Basket, Type A		<b>100, 160, 180, 200</b>	67 x 34 x 20		9003414 67070 9					
Suspension Basket, Type B		<b>130</b>	54,5 x 50 x 20		9003414 67071 6					
Suspension Basket, Type C		<b>160, 180, 200</b>	68,5 x 67 x 20		9003414 67072 3					
Parcel Box Kit		<b>for all sizes</b>	16,5 x 26,5 x 5		9003414 67020 4					

Parcel Box	Size	Exterior Dimensions	Interior Dimensions	Volume	Weight	EAN Code				
		W x L x H (cm)	W x L x H (cm)	(L)	(kg)	White	Metallic Silver	Met. Quartz Grey	Met. Dark Grey	Met. Bronze
	<b>100</b>	101 x 46 x 61	92 x 37,5 x 56	193,2	19,9	9003414 61910 4	9003414 64910 1	9003414 68910 7	9003414 65910 0	9003414 62910 3

StyleBox®	Size	Exterior Dimensions	Interior Dimensions	Volume	Weight	EAN Code		
		W x L x H (cm)	W x L x H (cm)	(L)	(kg)	Metallic Silver	Metallic Quartz Grey	Metallic Dark Grey
	<b>140</b>	140 x 60 x 71	139 x 56 x 64	498,2	44,0	9003414 19830 2	9003414 19832 6	9003414 19831 9
	<b>170</b>	170 x 70 x 81	169 x 66 x 74	825,4	58,9	9003414 19833 3	9003414 19835 7	9003414 19834 0
	<b>210</b>	207 x 80 x 81	206 x 76 x 74	1.158,5	74,6	9003414 19836 4	9003414 19838 8	9003414 19837 1
Accessories		For Size	Dimensions W x L x H (cm)		EAN Code			
Lid Storage Net		<b>for all sizes</b>	25 x 67 x 2		9003414 67010 5			
Suspension Basket Type D		<b>140</b>	48,5 x 50,5 x 20		9003414 67073 0			
Suspension Basket Type E		<b>170</b>	59 x 50,5 x 20		9003414 67074 7			
Suspension Basket Type C		<b>210</b>	68,5 x 67 x 20		9003414 67072 3			
Castors		<b>for all sizes</b>	6 x 3 x 3,6, 2 pieces per package		9003414 67030 3			

LoungeBox®	Size	Exterior Dimensions	Interior Dimensions	Volume	Weight	EAN Code		
		W x L x H (cm)	W x L x H (cm)	(L)	(kg)	Metallic Silver	Metallic Quartz Grey	Metallic Dark Grey
	<b>160</b>	160 x 70 x 83,5	159 x 65 x 78	806,1	50,1	9003414 64065 8	9003414 68065 4	9003414 65065 7
	<b>200</b>	200 x 85 x 90	199 x 78 x 83	1.288,3	71,9	9003414 64075 7	9003414 68075 3	9003414 65075 6
Accessories		For Size	Dimensions W x L x H (cm)		EAN Code			
Lid Storage Net		<b>for all sizes</b>	25 x 67 x 2		9003414 67010 5			
Suspension Basket, Type B		<b>160</b>	54,5 x 50 x 20		9003414 67071 6			
Suspension Basket, Type C		<b>200</b>	68,5 x 67 x 20		9003414 67072 3			

HighBoard	Size	Exterior Dimensions	Interior Dimensions	Volume	Weight	EAN Code		
		W x L x H (cm)	W x L x H (cm)	(L)	(kg)	Metallic Silver	Metallic Quartz Grey	Metallic Dark Grey
	<b>160</b>	160,5 x 70,5 x 118	156 x 62 x 113	1.092,9	82,7	9003414 <b>72015</b> 2	9003414 <b>70015</b> 4	9003414 <b>73015</b> 1
	<b>200</b>	200,5 x 84,5 x 127	195 x 76 x 120	1.778,4	114,5	9003414 <b>72025</b> 1	9003414 <b>70025</b> 3	9003414 <b>73025</b> 0
Accessories		for size Dimensions W x L x H (cm)			EAN Code			
Tool Holder	<b>160, 200</b>	51,6 x 3,5 x 5			9003414 <b>47031</b> 6	9003414 <b>47081</b> 1	9003414 <b>47051</b> 4	
Accessories		For Size Dimensions W x L x H (cm)			EAN Code			
Lid Storage Net	<b>160, 200</b>	25 x 67 x 2			9003414 <b>67010</b> 5			
Intermediate Shelf	<b>160</b>	78 x 30 x 53,5 per shelf (4-pieces)			9003414 <b>75015</b> 9			
	<b>200</b>	97 x 74 x 53,5 per shelf (2-pieces)			9003414 <b>75025</b> 8			
Suspension Basket, Type B	<b>160</b>	54,5 x 50 x 20			9003414 <b>67071</b> 6			
Suspension Basket, Type C	<b>200</b>	68,5 x 67 x 20			9003414 <b>67072</b> 3			
BikeHolder	<b>200</b>	72 x 10 x 33			9003414 <b>49012</b> 3			
Electric Mounting Panel	<b>200</b>	58 x 2 x 23			9003414 <b>46032</b> 4			
Bin Bag Holder	<b>160</b>	43,8 x 60 x 4,4			9003414 <b>75016</b> 6			
	<b>200</b>	43,8 x 73,8 x 4,4			9003414 <b>75026</b> 5			

StoreMax®	Size	Exterior Dimensions	Interior Dimensions	Volume	Weight	EAN Code		
		W x L x H (cm)	W x L x H (cm)	(L)	(kg)	Metallic Silver	Metallic Quartz Grey	Metallic Dark Grey
	<b>120</b>	117 x 73 x 109	114 x 62 x 104,6	739,3	48,2	9003414 <b>72060</b> 2	9003414 <b>70060</b> 4	9003414 <b>73060</b> 1
	<b>160</b>	163 x 78 x 120	160 x 67 x 115,6	1.239,2	65,1	9003414 <b>72010</b> 7	9003414 <b>70010</b> 9	9003414 <b>73010</b> 6
	<b>190</b>	190 x 97 x 136	188 x 86 x 131,6	2.127,7	88,8	9003414 <b>72020</b> 6	9003414 <b>70020</b> 8	9003414 <b>73020</b> 5
Accessories		For Size Dimensions W x L x H (cm)			EAN Code			
Corner Shelf Set (triangular)	<b>120, 160</b>	54 x 54 x 53,5			9003414 <b>74010</b> 5			
Intermediate Shelf	<b>160</b>	160 (2 x 80) x 59,5 x 53,5			9003414 <b>75010</b> 4			
	<b>190</b>	187 (2 x 93,5) x 74,5 x 53,5			9003414 <b>75020</b> 3			
Shelf Set	<b>190</b>	72 x 24,5 x 53,5			9003414 <b>74020</b> 4			
BikeHolder	<b>190</b>	72 x 15 x 33			9003414 <b>74030</b> 3			

MiniGarage	Size	Exterior Dimensions	Interior Dimensions	Foundation Dimensions	Weight	EAN Code		
		W x L x H (cm)	W x L x H (cm)	W x L (cm)	(kg)	Metallic Silver	Metallic Quartz Grey	Metallic Dark Grey
	<b>L</b>	145 x 203 x 151	140 x 195 x 143,5	145 x 203	107,5	9003414 <b>55040</b> 7	9003414 <b>58040</b> 4	9003414 <b>56040</b> 6
Accessories		Dimensions W x L x H (cm)			EAN Code			
Aluminium Floor Frame*		140 x 198 x 4			9003414 <b>41032</b> 9			
Ground Anchor**		4 pieces per package (8 pieces are needed in total)			9003414 <b>41004</b> 6			
Aluminium Floor Panels*		131,6 x 189,7 x 0,2			9003414 <b>48032</b> 2			
SmartBase*		140 x 198 x 18			9003414 <b>43938</b> 2			
SmartBase <sup>PLUS</sup> *		140 x 198 x 65			9003414 <b>43439</b> 4			
Shelf Set*		77 x 26,8 x 14 per shelf, incl. shelf supports			9003414 <b>45013</b> 4			
Bike Rail*		17,9 x 199,9 x 139,5			9003414 <b>49014</b> 7			
Electric Mounting Panel*		77,1 x 3,3 x 140			9003414 <b>46039</b> 3			
LED Light		44 x 4 x 1,5			9003414 <b>46041</b> 6			

\*Please note that the size of the MiniGarage has changed. The accessories only fit the "Model 2023 / Size L" with the dimensions 145 x 203 x 150 cm. Please check carefully that you have the correct size to use the accessory properly.

\*\*If the floor frame is laid directly on a gravel base (approx. 10 cm gravel, without foundation or slabs), ground anchors are required for securing to the ground. Storm resistance must be ensured by the customer.

Alex®	Exterior Dimensions	Interior Dimensions	Volume	Weight	EAN Code		
	W x L x H (cm)	W x L x H (cm)	(L)	(kg)	Metallic Silver	Metallic Quartz Grey	Metallic Dark Grey
	80 x 88 x 129	74,4 x 80 x 124,7	742,2	53,7	9003414 <b>53063</b> 8	9003414 <b>58068</b> 8	9003414 <b>54064</b> 4
If 3 or more Alex® wheeie bin boxes are ordered, a quantity discount is given.							
Left door hinge					9003414 <b>59065</b> 6	9003414 <b>59065</b> 6	9003414 <b>59065</b> 6
Accessories					Metallic Silver	Metallic Quartz Grey	Metallic Dark Grey
Connecting Element	For 2 Alex® units (one connection)			9003414 <b>53067</b> 6	9003414 <b>58067</b> 1	9003414 <b>54067</b> 5	
	For 3 Alex® units (two connections)			9003414 <b>53069</b> 0	9003414 <b>58069</b> 5	9003414 <b>54069</b> 9	
Matching Cylinder Locks	For 2 Alex® units			9003414 <b>50040</b> 2	9003414 <b>50040</b> 2	9003414 <b>50040</b> 2	
	For 3 Alex® units			9003414 <b>50041</b> 9	9003414 <b>50041</b> 9	9003414 <b>50041</b> 9	
Shelves	72 x 43,5 x 12,5			9003414 <b>45030</b> 1	9003414 <b>45030</b> 1	9003414 <b>45030</b> 1	
Shelf Support Rails	3,3 x 3,3 x 121,8			9003414 <b>46022</b> 5	9003414 <b>46022</b> 5	9003414 <b>46022</b> 5	

Alex® Duo	Exterior Dimensions	Interior Dimensions	Volume	Weight	EAN Code		
	W x L x H (cm)	W x L x H (cm)	(L)	(kg)	Metallic Silver	Metallic Quartz Grey	Metallic Dark Grey
	Door opening: 129 x 118 cm (W x H)						
	147 x 88 x 129	142 x 79 x 128	1.435,9	67,1	9003414 <b>53090 4</b>	9003414 <b>58090 9</b>	9003414 <b>54090 3</b>
Accessories	Dimensions W x L x H (cm)			EAN Code			
<b>Floor Kit</b> (threshold ramp, aluminium floor plate*, aluminium floor frame**)	142 x 94 x 4			9003414 <b>57094 8</b>			
Note: If the floor frame is laid directly on a gravel base (approx. 10 cm gravel, without foundation or slabs), ground anchors are required for securing to the ground. Storm resistance must be ensured by the customer. For Alex® Duo: a total of 8 pieces necessary.							
Ground Anchor	1,5 x 4,5 x 53, 4 pieces per package			9003414 <b>41004 6</b>			
Shelf Support Rails	5,3 x 2,2 x 122,3, 2 pieces per package			9003414 <b>46024 9</b>			
Shelves	56 x 26 x 17,3, 2 pieces per package			9003414 <b>45040 0</b>			
Shelves (deep)	56 x 44,5 x 17,3, 2 pieces per package			9003414 <b>45060 8</b>			

\*Aluminium floor panels: 2 mm aluminium checker plate. Aluminium floor frame required for optimal installation. Underlayment with a fill or XPS hard foam boards in a thickness of approx. 2-3 cm recommended (not included in the scope of delivery).

\*\*Aluminium floor frame: Aluminium square tubing (40 x 40 mm) with corner joints and fixing material (screws)

## BikeLift® for Wall Mounting

BikeLift®	Variant	Exterior Dimensions	Weight	EAN Code
		W x L x H (cm)	(kg)	Metallic Dark Grey
	<b>Standard</b>	16,1 x 38,1 x 180	9,8	9003414 <b>49054 3</b>
	<b>Swivel Mount</b>	16,4 x 52,6 x 181,8	13,0	9003414 <b>49055 0</b>
Accessories				EAN Code
Electric Socket Mounting Panel	can be combined with all variants	9,6 x 11,8 x 4,3	0,2	9003414 <b>49059 8</b>

Fits almost any bike. Check your bike: [www.biohort.com/bikelift](http://www.biohort.com/bikelift)

## Cleaning Agents

CleanLine		Volume	EAN Code
	<b>Universal Cleaner</b>	With strong dissolving power against grease, oil, algae and dirt of all kinds. Forms a short-term dirt and water-repellent surface. Perfect for removing fingerprints after assembly.	1000 ml 9003414 <b>99000 5</b>
	<b>Conservation</b>	Leaves a water and dirt-repellent protective film (lotus effect). Protect your Biohort product from environmental influences and at the same time ensure a silky matt shine.	750 ml 9003414 <b>99100 2</b>
	<b>Saver Set</b>	(Universal Cleaner + Conservation)	1000 ml + 750 ml 9003414 <b>99200 9</b>

## Outdoor Living



### CasaVita® – Your Extended Living Space

Available in **two colours** and **10 sizes**.

The full range of variants, accessories and technical details can be found at [www.biohort.com/casavita](http://www.biohort.com/casavita).







Product Info



Pergola	Size	Exterior Dimensions	Interior Dimensions	Weight (kg)	Colour Combination			EAN Code				
		W x L x H (cm)	W x L x H (cm)		Frame Colour	Louvre Colour	Variants					
	3x3	312 x 312 x 264	272 x 272 x 235	243,8	Metallic Quartz Grey	Metallic Quartz Grey	1	9003414 92217 4				
						Metallic Silver	1.2	9003414 92219 8				
						White	1.3	9003414 94946 1				
					Metallic Dark Grey	Metallic Dark Grey	1.4	9003414 92216 7				
						Metallic Silver	1.5	9003414 92218 1				
						White	1.6	9003414 94916 4				
					White	White	1.7	9003414 94602 6				
						Metallic Silver	1.8	9003414 94771 9				
					3,5x3	367,5 x 312 x 264	328 x 272 x 235	266,2	Metallic Quartz Grey	Metallic Quartz Grey	2	9003414 92221 1
										Metallic Silver	2.2	9003414 92223 5
White	2.3	9003414 94950 8										
Metallic Dark Grey	Metallic Dark Grey	2.4	9003414 92220 4									
	Metallic Silver	2.5	9003414 92222 8									
	White	2.6	9003414 94918 8									
White	White	2.7	9003414 94604 0									
	Metallic Silver	2.8	9003414 94773 3									
4x3	404,5 x 312 x 264	365 x 272 x 235	293,2	Metallic Quartz Grey					Metallic Quartz Grey	3	9003414 92225 9	
									Metallic Silver	3.2	9003414 92227 3	
					White	3.3	9003414 94954 6					
				Metallic Dark Grey	Metallic Dark Grey	3.4	9003414 92224 2					
					Metallic Silver	3.5	9003414 92226 6					
					White	3.6	9003414 94920 1					
				White	White	3.7	9003414 94606 4					
					Metallic Silver	3.8	9003414 94775 7					
				3x3,5	312 x 367,5 x 264	272 x 328 x 235	271,5	Metallic Quartz Grey	Metallic Quartz Grey	4	9003414 92389 8	
									Metallic Silver	4.2	9003414 92391 1	
White	4.3	9003414 92391 1										
Metallic Dark Grey	Metallic Dark Grey	4.4	9003414 92388 1									
	Metallic Silver	4.5	9003414 92390 4									
	White	4.6	9003414 94917 1									
White	White	4.7	9003414 94603 3									
	Metallic Silver	4.8	9003414 94772 6									
3,5x3,5	367,5 x 367,5 x 264	328 x 328 x 235	296,9					Metallic Quartz Grey	Metallic Quartz Grey	5	9003414 92229 7	
									Metallic Silver	5.2	9003414 92231 0	
				White	5.3	9003414 95063 4						
				Metallic Dark Grey	Metallic Dark Grey	5.4	9003414 92228 0					
					Metallic Silver	5.5	9003414 92230 3					
					White	5.6	9003414 94919 5					
				White	White	5.7	9003414 94605 7					
					Metallic Silver	5.8	9003414 94774 0					
				4x3,5	404,5 x 367,5 x 264	365 x 328 x 235	328,5	Metallic Quartz Grey	Metallic Quartz Grey	6	9003414 92233 4	
									Metallic Silver	6.2	9003414 92235 8	
White	6.3	9003414 94956 0										
Metallic Dark Grey	Metallic Dark Grey	6.4	9003414 92232 7									
	Metallic Silver	6.5	9003414 92234 1									
	White	6.6	9003414 94921 8									
White	White	6.7	9003414 94607 1									
	Metallic Silver	6.8	9003414 94776 4									

Pergola	Size	Exterior Dimensions	Interior Dimensions	Weight	Colour Combination			EAN Code	
		W x L x H (cm)	W x L x H (cm)	(kg)	Frame Colour	Louvre Colour	Variants		
	4.5x3	460 x 312 x 264	420 x 272 x 235	314,7	Metallic Quartz Grey	Metallic Quartz Grey	7	9003414 94822 8	
						Metallic Silver	7.2	9003414 95065 8	
						White	7.3	9003414 94959 1	
					Metallic Dark Grey	Metallic Dark Grey	7.4	9003414 94821 1	
						Metallic Silver	7.5	9003414 95066 5	
						White	7.6	9003414 94923 2	
					White	White	7.7	9003414 94820 4	
						Metallic Silver	7.8	9003414 95067 2	
	Metallic Quartz Grey	Metallic Quartz Grey	8	9003414 94825 9					
	4.5x3.5	460 x 367,5 x 264	420 x 327,5 x 235	353,0	Metallic Quartz Grey	Metallic Quartz Grey	8.2	9003414 95077 1	
						Metallic Silver	8.3	9003414 94961 4	
						White	8.4	9003414 94824 2	
					Metallic Dark Grey	Metallic Dark Grey	8.5	9003414 95078 8	
						Metallic Silver	8.6	9003414 94925 6	
						White	8.7	9003414 94823 5	
					White	White	8.8	9003414 95079 5	
						Metallic Quartz Grey	Metallic Quartz Grey	9	9003414 94828 0
	Metallic Quartz Grey	Metallic Quartz Grey	9.2	9003414 95068 9					
		Metallic Silver	9.3	9003414 94965 2					
		White	9.4	9003414 94827 3					
	5x3	515,5 x 312 x 264	475,5 x 272 x 235	347,4	Metallic Dark Grey	Metallic Dark Grey	9.5	9003414 95069 6	
						Metallic Silver	9.6	9003414 94928 7	
						White	9.7	9003414 94826 6	
					White	White	9.8	9003414 95070 2	
						Metallic Quartz Grey	Metallic Quartz Grey	10	9003414 94865 5
						Metallic Quartz Grey	Metallic Quartz Grey	10.2	9003414 95081 8
					Metallic Silver		10.3	9003414 94970 6	
					White		10.4	9003414 94864 8	
	5x3.5	515,5 x 367,5 x 264	475,5 x 327,5 x 235	391,3	Metallic Dark Grey	Metallic Dark Grey	10.5	9003414 95082 5	
						Metallic Silver	10.6	9003414 94930 0	
						White	10.7	9003414 94860 0	
					White	White	10.8	9003414 95083 2	
						Metallic Quartz Grey	Metallic Quartz Grey	11	9003414 94868 6
						Metallic Quartz Grey	Metallic Quartz Grey	11.2	9003414 95071 9
					Metallic Silver		11.3	9003414 94971 3	
					White		11.4	9003414 94867 9	
	5.5x3	552,5 x 312 x 264	512,5 x 272 x 235	362,1	Metallic Dark Grey	Metallic Dark Grey	11.5	9003414 95072 6	
						Metallic Silver	11.6	9003414 94931 7	
						White	11.7	9003414 94866 2	
					White	White	11.8	9003414 95073 3	
						Metallic Quartz Grey	Metallic Quartz Grey	12	9003414 94879 2
						Metallic Quartz Grey	Metallic Quartz Grey	12.2	9003414 95084 9
					Metallic Silver		12.3	9003414 94974 4	
					White		12.4	9003414 94878 5	
	5.5x3.5	552,5 x 367,5 x 264	512,5 x 327,5 x 235	408,0	Metallic Dark Grey	Metallic Dark Grey	12.5	9003414 95085 6	
						Metallic Silver	12.6	9003414 94933 1	
						White	12.7	9003414 94877 8	
					White	White	12.8	9003414 95086 3	
Metallic Quartz Grey						Metallic Quartz Grey	13	9003414 94882 2	
Metallic Quartz Grey						Metallic Quartz Grey	13.2	9003414 95074 0	
					Metallic Silver	13.3	9003414 94975 1		
					White	13.4	9003414 94881 5		
6x3	608 x 312 x 264	568 x 272 x 235	395,8	Metallic Dark Grey	Metallic Dark Grey	13.5	9003414 95075 7		
					Metallic Silver	13.6	9003414 94937 9		
					White	13.7	9003414 94880 8		
				White	White	13.8	9003414 95076 4		
					Metallic Quartz Grey	Metallic Quartz Grey	14	9003414 94885 3	
					Metallic Quartz Grey	Metallic Quartz Grey	14.2	9003414 95087 0	
				Metallic Silver		14.3	9003414 94977 5		
				White		14.4	9003414 94884 6		
6x3.5	608 x 367,5 x 264	568 x 327,5 x 235	447,3	Metallic Dark Grey	Metallic Dark Grey	14.5	9003414 95088 7		
					Metallic Silver	14.6	9003414 94941 6		
					White	14.7	9003414 94883 9		
				White	White	14.8	9003414 95089 4		
					Metallic Quartz Grey	Metallic Quartz Grey	14.9		
					Metallic Silver	15.0			

Accessories	Size	Weight (kg)	EAN Code		
			Metallic Dark Grey	Metallic Quartz Grey	White
*Control set must be ordered separately.					
Electric Drive*	for all sizes	2,3	9003414 92242 6		
Control Set EU / CH / UK (including remote control)	for all sizes	3,2	EU:	9003414 <b>92624</b> 0	
			CH:	9003414 <b>93301</b> 9	
			UK:	9003414 <b>93302</b> 6	
Warm White LED Lighting*	3x3	2,2	9003414 <b>95529</b> 5		
	3,5x3 / 4x3	2,4	9003414 <b>95530</b> 1		
	3,5x3,5 / 4x3,5 / 4,5x3	2,5	9003414 <b>95531</b> 8		
	4,5x3,5 / 5x3 / 5x3,5 / 5,5x3	2,7	9003414 <b>95532</b> 5		
	5,5x3,5 / 6x3 / 6x3,5	2,9	9003414 <b>95533</b> 2		
Motorised Sun Screen*	for 3 m side	19,0	9003414 <b>95451</b> 9	9003414 <b>95461</b> 8	9003414 <b>95467</b> 0
	for 3.5 m side	21,8	9003414 <b>95455</b> 7	9003414 <b>95463</b> 2	9003414 <b>95468</b> 7
	for 4 m side	23,0	9003414 <b>95459</b> 5	9003414 <b>95465</b> 6	9003414 <b>95469</b> 4
Sun Screen Manually	for 3 m side	19,0	9003414 <b>92236</b> 5	9003414 <b>92237</b> 2	9003414 <b>94720</b> 7
	for 3.5 m side	21,8	9003414 <b>92238</b> 9	9003414 <b>92239</b> 6	9003414 <b>94721</b> 4
	for 4 m side	23,0	9003414 <b>92240</b> 2	9003414 <b>92241</b> 9	9003414 <b>94722</b> 1
Louvred Side Wall with End Trim	2 m	70,6	9003414 <b>94782</b> 5	9003414 <b>94783</b> 2	9003414 <b>94781</b> 8
	2.5 m	91,6	9003414 <b>94799</b> 3	9003414 <b>94800</b> 6	9003414 <b>94798</b> 6
	3 m	99,9	9003414 <b>92243</b> 3	9003414 <b>92244</b> 0	9003414 <b>94684</b> 2
	3.5 m	116,7	9003414 <b>92245</b> 7	9003414 <b>92246</b> 4	9003414 <b>94693</b> 4
	4 m	130,6	9003414 <b>92247</b> 1	9003414 <b>92248</b> 8	9003414 <b>94694</b> 1
Sliding Glass Wall Clear Glass	for 3 m side	317,3	9003414 <b>95762</b> 6	9003414 <b>95765</b> 7	9003414 <b>95764</b> 0
	for 3.5 m side	349,7	9003414 <b>95769</b> 5	9003414 <b>95767</b> 1	9003414 <b>95772</b> 5
	for 4 m side	376,2	9003414 <b>95775</b> 6	9003414 <b>95773</b> 2	9003414 <b>95777</b> 0
	for 4.5 m side	412,1	9003414 <b>95790</b> 9	9003414 <b>95789</b> 3	9003414 <b>95791</b> 6
	for 5 m side	443,4	9003414 <b>95793</b> 0	9003414 <b>95792</b> 3	9003414 <b>95794</b> 7
	for 5.5 m side	464,8	9003414 <b>95796</b> 1	9003414 <b>95795</b> 4	9003414 <b>95797</b> 8
	for 6 m side	496,7	9003414 <b>95799</b> 2	9003414 <b>95798</b> 5	9003414 <b>95800</b> 5
Height-adjustable Base Plate	20 x 20 x 25,5	3,4	9003414 <b>95811</b> 1	9003414 <b>95810</b> 4	9003414 <b>95812</b> 8

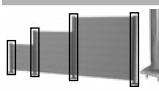
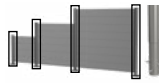
Privacy Screen Panel without Acrylic Glass	Size	Exterior Dimensions		Weight		EAN Code		
		W x L x H (cm)		(kg)		Metallic Silver	Metallic Quartz Grey	Metallic Dark Grey
<b>Height: 90 cm</b>	Consists of wall panels and two guide rails for the assembly between two privacy screen posts, can also be attached to a house wall or similar							
	<b>100 x 90</b>	96 x 4,4 x 91		13,2		9003414 15924 2	9003414 15920 4	9003414 15892 4
	<b>150 x 90</b>	145 x 4,4 x 91		17,7		9003414 15925 9	9003414 15921 1	9003414 15893 1
	<b>180 x 90</b>	180 x 4,4 x 91		21,5		9003414 15926 6	9003414 15922 8	9003414 15894 8
	<b>200 x 90</b>	194 x 4,4 x 91		22,9		9003414 15928 0	9003414 15923 5	9003414 15917 4
<b>Height: 135 cm</b>	Consists of wall panels and two guide rails for the assembly between two privacy screen posts, can also be attached to a house wall or similar							
	<b>100 x 135</b>	96 x 4,4 x 137		20,3		9003414 15981 5	9003414 15977 8	9003414 15973 0
	<b>150 x 135</b>	145 x 4,4 x 137		27,2		9003414 15982 2	9003414 15978 5	9003414 15974 7
	<b>180 x 135</b>	180 x 4,4 x 137		33,4		9003414 15983 9	9003414 15979 2	9003414 15975 4
	<b>200 x 135</b>	194 x 4,4 x 137		35,5		9003414 15984 6	9003414 15980 8	9003414 15976 1
<b>Height: 180 cm</b>	Consists of wall panels and two guide rails for the assembly between two privacy screen posts, can also be attached to a house wall or similar							
	<b>100 x 180</b>	96 x 4,4 x 182		25,7		9003414 16046 0	9003414 16042 2	9003414 16038 5
	<b>150 x 180</b>	145 x 4,4 x 182		34,7		9003414 16047 7	9003414 16043 9	9003414 16039 2
	<b>180 x 180</b>	180 x 4,4 x 182		42,3		9003414 16048 4	9003414 16044 6	9003414 16040 8
	<b>200 x 180</b>	194 x 4,4 x 182		45,1		9003414 16049 1	9003414 16045 3	9003414 16041 5
Privacy Screen Panel with Acrylic Glass	Size	Exterior Dimensions		Weight		EAN Code		
		W x L x H (cm)		(kg)		Metallic Silver	Metallic Quartz Grey	Metallic Dark Grey
<b>Height: 90 cm</b>	Consists of wall panels, tinted glass panel and two guide rails for the assembly between two privacy screen posts, can also be attached to a house wall or similar							
	<b>100 x 90</b>	96 x 4,4 x 91		13,1		9003414 15969 3	9003414 15965 5	9003414 15961 7
	<b>150 x 90</b>	145 x 4,4 x 91		17,7		9003414 15970 9	9003414 15966 2	9003414 15962 4
	<b>180 x 90</b>	180 x 4,4 x 91		21,1		9003414 15971 6	9003414 15967 9	9003414 15963 1
	<b>200 x 90</b>	194 x 4,4 x 91		22,3		9003414 15972 3	9003414 15968 6	9003414 15964 8
<b>Height: 135 cm</b>	Consists of wall panels, tinted glass panel and two guide rails for the assembly between two privacy screen posts, can also be attached to a house wall or similar							
	<b>100 x 135</b>	96 x 4,4 x 137		20,2		9003414 16034 7	9003414 15989 1	9003414 15985 3
	<b>150 x 135</b>	145 x 4,4 x 137		27,2		9003414 16035 4	9003414 15990 7	9003414 15986 0
	<b>180 x 135</b>	180 x 4,4 x 137		33,0		9003414 16036 1	9003414 15991 4	9003414 15987 7
	<b>200 x 135</b>	194 x 4,4 x 137		34,9		9003414 16037 8	9003414 15992 1	9003414 15988 4
<b>Height: 180 cm</b>	Consists of wall panels, tinted glass panel and two guide rails for the assembly between two privacy screen posts, can also be attached to a house wall or similar							
	<b>100 x 180</b>	96 x 4,4 x 182		25,6		9003414 16058 3	9003414 16054 5	9003414 16050 7
	<b>150 x 180</b>	145 x 4,4 x 182		34,7		9003414 16059 0	9003414 16055 2	9003414 16051 4
	<b>180 x 180</b>	180 x 4,4 x 182		41,9		9003414 16060 6	9003414 16056 9	9003414 16052 1
	<b>200 x 180</b>	194 x 4,4 x 182		44,5		9003414 16229 7	9003414 16057 6	9003414 16053 8
Post for Privacy Screen	suitable for height	Min. Height	Base Plate*	Weight	EAN Code			
		Max. Height	W x L (cm)	(kg)	Metallic Silver	Metallic Quartz Grey	Metallic Dark Grey	
<b>Post for anchoring</b>	They are bolted to the ground. For surface anchoring, the posts can be used as starting, end, corner or connecting post for the privacy screen panels. Choose the wall panels to match the height of the post! Diameter: 10 cm. One post per article.							
	<b>90 cm</b>	<b>95 – 120</b>	15 x 15	10,5	9003414 16342 3	9003414 16341 6	9003414 16340 9	
	<b>135 cm</b>	<b>140 – 165</b>	15 x 15	11,4	9003414 16345 4	9003414 16344 7	9003414 16343 0	
	<b>180 cm</b>	<b>185 – 210</b>	15 x 15	13,1	9003414 16348 5	9003414 16347 8	9003414 16346 1	
<b>Post for setting in concrete</b>	Are embedded in a point foundation. For surface anchoring, the posts can be used as starting, end, corner or connecting post for the privacy screen panels. Choose the wall panels to match the height of the post! Diameter: 10 cm. One post per article.							
	<b>90 cm</b>	<b>95 – 120</b>		10,2	9003414 17336 1	9003414 17342 2	9003414 17339 2	
	<b>135 cm</b>	<b>140 – 165</b>		11,7	9003414 17337 8	9003414 17343 9	9003414 17340 8	
	<b>180 cm</b>	<b>185 – 210</b>		13,8	9003414 17338 5	9003414 17344 6	9003414 17341 5	

\*The cover plate of the base plate has the dimensions 18 x 18 cm.

Mounting Accessories	For Anchored Post	EAN Code
<b>Hammer Drill Bit</b>	The hammer drill bit is used to drill the required holes in the concrete foundation for the injection mortar. A hammer drill is available in specialist shops.	for SDS plus chuck Ø14 mm Length: 150 mm 9003414 18784 9
<b>Blow-out Pump and Cleaning Brush</b>	The pump is used for a safe and easy cleaning of the drill hole. The cleaning brush is used to remove any dust from the sides of the drill hole. This ensures that the injection mortar adheres to the concrete foundation.	9003414 18785 6
<b>Injection Mortar</b>	The injection mortar is required to bond the threaded rod anchors securely in the concrete.	Content 300 ml Sufficient for minimum of 16 pcs. Anchor rods M12 x 160 9003414 18782 5
<b>Applicator Gun</b>	The injection mortar is precisely applied with the aid of the applicator gun. This is achieved by transmission without great effort.	Suitable for 310ml cartridges 9003414 18783 2
<b>Threaded Rod Anchors</b>	The anchors are glued into the foundation and guarantee a secure connection between foundation and Biohort Privacy Screen including base plate. Per article 4 pcs. – is enough for a post.	M12 x 160 R Includes nuts and washers 9003414 18786 3

## Planting Beds



Raised Bed	Size	Exterior Dimensions	Interior Dimensions	Volume (L)	Weight (kg)	EAN Code		
		W x L x H (cm)	W x L x H (cm)			Metallic Silver	Metallic Quartz Grey	Metallic Dark Grey
	1x0,5	103,1 x 53,8 x 77	95 x 46 x 77	336,5	34,6	9003414 64012 2	9003414 68012 8	9003414 65012 1
	1x1	103,1 x 103,1 x 77	95 x 95 x 77	694,9	43,2	9003414 64005 4	9003414 68005 0	9003414 65005 3
	1,5x0,5	152 x 53,8 x 77	145 x 46 x 77	513,6	41,3	9003414 64028 3	9003414 68028 9	9003414 65028 2
	1,5x1	152 x 103,1 x 77	145 x 95 x 77	1.060,7	49,9	9003414 64018 4	9003414 68018 0	9003414 65018 3
	1,5x1,5	152 x 152 x 77	145 x 145 x 77	1.618,9	56,6	9003414 64048 1	9003414 68048 7	9003414 65048 0
	2x0,5	201,6 x 53,8 x 77	194 x 46 x 77	687,2	47,6	9003414 64022 1	9003414 68022 7	9003414 65022 0
	2x1	201,6 x 103,1 x 77	194 x 95 x 77	1.419,1	52,9	9003414 64015 3	9003414 68015 9	9003414 65015 2
	2x2	201,6 x 201,6 x 77	194 x 194 x 77	2.898,0	76,4	9003414 64035 1	9003414 68035 7	9003414 65035 0
	L2x1	201,6 x 201,6 x 77	194 x 194 x 77	2.898,0	82,6	9003414 64025 2	9003414 68025 8	9003414 65025 1
	4x1	397 x 103,1 x 77	391 x 96 x 77	2.890,3	96,8	9003414 64085 6	9003414 68085 2	9003414 65085 5

Accessories	For Size	Dimensions W x L x H (cm)	Metallic Silver	Metallic Quartz Grey	Metallic Dark Grey
Intermediate Floor	1x0,5	98 x 50,8 x 3			9003414 65042 8
	1x1	98 x 100 x 3			9003414 65046 6
	1,5x0,5	147 x 51 x 3			9003414 65045 9
	2x0,5	196 x 50,8 x 3			9003414 65043 5
	1,5x1	147 x 98 x 3			9003414 65049 7
	2x1	196 x 100 x 3			9003414 65047 3
	4x1	393,7 x 100 x 3			9003414 65039 8
Cold Frame Extension	2x1	200,2 x 101,8 x 28,5	9003414 64013 9	9003414 68013 5	9003414 65013 8
Slug Guard	1x0,5	110,3 x 60,7 x 4,3	9003414 16349 2	9003414 16351 5	9003414 16350 8
	1x1	110,3 x 110,3 x 4,3	9003414 16370 6	9003414 16372 0	9003414 16371 3
	1,5x0,5	159,3 x 60,7 x 4,3	9003414 16367 6	9003414 16369 0	9003414 16368 3
	2x0,5	208,7 x 60,7 x 4,3	9003414 16355 3	9003414 16357 7	9003414 16356 0
	1,5x1	159,3 x 110,3 x 4,3	9003414 16364 5	9003414 16366 9	9003414 16365 2
	2x1	208,7 x 110,3 x 4,3	9003414 16352 2	9003414 16354 6	9003414 16353 9
	1,5x1,5	159,3 x 159,3 x 4,3	9003414 16361 4	9003414 16363 8	9003414 16362 1
2x2	208,7 x 208,7 x 4,3	9003414 16373 7	9003414 16375 1	9003414 16374 4	

The slug guard cannot be combined with the Florentina greenhouse extension.

Skirting	1x0,5	115 x 66,4 x 6,3	9003414 16399 7	9003414 16401 7	9003414 16400 0
	1x1	115 x 115 x 6,3	9003414 16396 6	9003414 16398 0	9003414 16397 3
	1,5x0,5	164 x 66,4 x 6,3	9003414 16393 5	9003414 16395 9	9003414 16394 2
	2x0,5	214 x 66,4 x 6,3	9003414 16382 9	9003414 16384 3	9003414 16383 6
	1,5x1	164 x 115 x 6,3	9003414 16390 4	9003414 16392 8	9003414 16391 1
	2x1	214 x 115 x 6,3	9003414 16379 9	9003414 16381 2	9003414 16380 5
	1,5x1,5	164 x 164 x 6,3	9003414 16385 0	9003414 16387 4	9003414 16386 7
	2x2	214 x 214 x 6,3	9003414 16376 8	9003414 16378 2	9003414 16377 5
	L2x1	214 x 214 x 6,3	9003414 16408 6	9003414 16410 9	9003414 16409 3
Trellis (1 pc.) (With L-size is 1 pc. also possible)	for 1 m side	102 x 4 x 91	9003414 16436 9	9003414 16438 3	9003414 16437 6
	for 1.5 m side	152 x 4 x 91	9003414 16439 0	9003414 16441 3	9003414 16440 6
	for 2 m side	201 x 4 x 91	9003414 16442 0	9003414 16444 4	9003414 16443 7
	for 4 m side	398,3 x 4,2 x 91,1	9003414 92340 9	9003414 92342 3	9003414 92341 6
Trellis L Form (2 pcs.)	1x1	102 x 102 x 91	9003414 16445 1	9003414 16447 5	9003414 16446 8
	2x2, L2x1	201 x 201 x 91	9003414 16451 2	9003414 16453 6	9003414 16452 9
Privacy Screen (1 pc.) (With L-size is 1 pc. also possible)	for 1 m side	102 x 4 x 91	9003414 16457 4	9003414 16459 8	9003414 16458 1
	for 1.5 m side	152 x 4 x 91	9003414 16460 4	9003414 16462 8	9003414 16461 1
	for 2 m side	201 x 4 x 91	9003414 16463 5	9003414 16465 9	9003414 16464 2
	for 4 m side	398,3 x 4,2 x 91,1	9003414 92343 0	9003414 92345 4	9003414 92344 7
Privacy Screen L Form (2 pcs.)	1x1	102 x 102 x 91	9003414 16466 6	9003414 16468 0	9003414 16467 3
	1,5x1,5	152 x 152 x 91	9003414 16469 7	9003414 16471 0	9003414 16470 3
	2x2, L2x1	201 x 201 x 91	9003414 16472 7	9003414 16474 1	9003414 16473 4
Privacy Screen with Glass Panels (1 pc.) (With L-size is 1 pc. also possible)	for 1 m side	102 x 4 x 91	9003414 16475 8	9003414 16477 2	9003414 16476 5
	for 1.5 m side	152 x 4 x 91	9003414 16478 9	9003414 16480 2	9003414 16479 6
	for 2 m side	201 x 4 x 91	9003414 16481 9	9003414 16483 3	9003414 16482 6
	for 4 m side	398,3 x 4,2 x 91,1	9003414 92346 1	9003414 92348 5	9003414 92347 8
Privacy Screen L Form with Glass Panels (2 pcs.)	1x1	102 x 102 x 91	9003414 16484 0	9003414 16486 4	9003414 16485 7
	1,5x1,5	152 x 152 x 91	9003414 16487 1	9003414 16489 5	9003414 16488 8
	2x2, L2x1	201 x 201 x 91	9003414 16490 1	9003414 16492 5	9003414 16491 8
Irrigation System	für 2x0,5, 2x1		9003414 95688 9		
Florentina Greenhouse Extension	2x0,5	201,6 x 54,8 x 136,4		9003414 95396 3	9003414 95395 6
	2x1	201,6 x 104 x 136,4		9003414 95398 7	9003414 95397 0

Accessories	For Size	Dimensions W x L x H (cm)	Metallic Silver	Metallic Quartz Grey	Metallic Dark Grey
Only available in combination with the greenhouse attachment.					
Plant Pot Set	2x0,5, 2x1	150,8 x 4,2 x 150,8		9003414 95701 5	
Weather Protection Plate	2x0,5	50,2 x 30,2 x 4,7		9003414 95699 5	
	2x1	99,5 x 30,2 x 4,7		9003414 95698 8	
Automatic Ventilation	2x0,5, 2x1	67 x 12,5 x 5,5		9003414 95693 3	
Florentina Trellis	2x0,5, 2x1	150,8 x 4,2 x 150,8		9003414 95700 8	

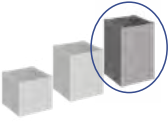
Belvedere®	Size	Exterior Dimensions	Interior Dimensions	Volume*	Weight	EAN Code			
		W x L x H (cm)	W x L x H (cm)	(L)	(kg)	Metallic Silver	Metallic Quartz Grey	Metallic Dark Grey	
	MINI Height: 45 cm								
	50 <sup>MINI</sup>	53,8 x 53,8 x 45	46 x 46 x 45	42	19,8	9003414 15888 7	9003414 15875 7	9003414 15853 5	
	100 <sup>MINI</sup>	103,1 x 53,8 x 45	95 x 46 x 45	90	27,3	9003414 15887 0	9003414 15874 0	9003414 15852 8	
	150 <sup>MINI</sup>	152 x 53,8 x 45	145 x 46 x 45	135	33,7	9003414 15885 6	9003414 15872 6	9003414 15850 4	
	200 <sup>MINI</sup>	201,6 x 53,8 x 45	194 x 46 x 45	180	39,9	9003414 15882 5	9003414 15869 6	9003414 15847 4	
	L100 <sup>MINI</sup>	103,1 x 103,1 x 45	95 x 95 x 45	130	38,8	9003414 15878 8	9003414 15865 8	9003414 15856 6	
	L150 <sup>MINI</sup>	152 x 152 x 45	145 x 145 x 45	225	53,5	9003414 15877 1	9003414 15864 1	9003414 15855 9	
	L200 <sup>MINI</sup>	201,6 x 201,6 x 45	194 x 194 x 45	315	66,5	9003414 15876 4	9003414 15863 4	9003414 15854 2	
	MIDI Height: 61 cm								
	50 <sup>MIDI</sup>	53,8 x 53,8 x 61	46 x 46 x 61	42	23,8	9003414 15940 2	9003414 15919 8	9003414 15904 4	
	100 <sup>MIDI</sup>	103,1 x 53,8 x 61	95 x 46 x 61	90	32,9	9003414 15939 6	9003414 15918 1	9003414 15903 7	
	150 <sup>MIDI</sup>	152 x 53,8 x 61	145 x 46 x 61	135	40,6	9003414 15937 2	9003414 15915 0	9003414 15901 3	
	200 <sup>MIDI</sup>	201,6 x 53,8 x 61	194 x 46 x 61	180	48,3	9003414 15934 1	9003414 15911 2	9003414 15898 6	
	L100 <sup>MIDI</sup>	103,1 x 103,1 x 61	95 x 95 x 61	130	46,4	9003414 15930 3	9003414 15907 5	9003414 15891 7	
	L150 <sup>MIDI</sup>	152 x 152 x 61	145 x 145 x 61	225	64,0	9003414 15929 7	9003414 15906 8	9003414 15890 0	
	L200 <sup>MIDI</sup>	201,6 x 201,6 x 61	194 x 194 x 61	315	79,8	9003414 15927 3	9003414 15905 1	9003414 15889 4	
	MAXI Height: 77 cm								
	50 <sup>MAXI</sup>	53,8 x 53,8 x 77	46 x 46 x 77	42	27,8	9003414 16021 7	9003414 16008 8	9003414 15953 2	
	100 <sup>MAXI</sup>	103,1 x 53,8 x 77	95 x 46 x 74	90	38,5	9003414 16020 0	9003414 16007 1	9003414 15952 5	
	150 <sup>MAXI</sup>	152 x 53,8 x 77	145 x 46 x 77	135	46,6	9003414 16018 7	9003414 16005 7	9003414 15950 1	
	200 <sup>MAXI</sup>	201,6 x 53,8 x 77	194 x 46 x 74	180	53,9	9003414 16015 6	9003414 16002 6	9003414 15947 1	
	L100 <sup>MAXI</sup>	103,1 x 103,1 x 77	95 x 95 x 77	130	54,0	9003414 16011 8	9003414 15998 3	9003414 15943 3	
	L150 <sup>MAXI</sup>	152 x 152 x 77	145 x 145 x 77	225	73,6	9003414 16010 1	9003414 15997 6	9003414 15942 6	
	L200 <sup>MAXI</sup>	201,6 x 201,6 x 77	194 x 194 x 77	315	93,0	9003414 16009 5	9003414 15996 9	9003414 15941 9	

Accessories	For Size	Dimensions W x L x H (cm)	Metallic Silver	Metallic Quartz Grey	Metallic Dark Grey
Slug Guard	100	110,3 x 60,7 x 4,3	9003414 16349 2	9003414 16351 5	9003414 16350 8
	150	159,3 x 60,7 x 4,3	9003414 16367 6	9003414 16369 0	9003414 16368 3
	200	208,7 x 60,7 x 4,3	9003414 16355 3	9003414 16357 7	9003414 16356 0

Note: The slug guard cannot be combined with the greenhouse Florentina extension.

Skirting	50	66,4 x 66,4 x 6,3	9003414 16402 4	9003414 16404 8	9003414 16403 1
	100	115 x 66,4 x 6,3	9003414 16399 7	9003414 16401 7	9003414 16400 0
	150	164 x 66,4 x 6,3	9003414 16393 5	9003414 16395 9	9003414 16394 2
	200	214 x 66,4 x 6,3	9003414 16382 9	9003414 16384 3	9003414 16383 6
	L100	115 x 115 x 6,3	9003414 16414 7	9003414 16416 1	9003414 16415 4
	L150	164 x 164 x 6,3	9003414 16411 6	9003414 16413 0	9003414 16412 3
	L200	214 x 214 x 6,3	9003414 16405 5	9003414 16407 9	9003414 16406 2

\*Dimensions of planter insert (W x L x H): 50 x 50 x 18 cm; size 50: 1 pc. possible; size 100: 2 pcs. possible; size 150, L100: 3 pcs. possible; size 200: 4 pcs. possible; size L150: 5 pcs. possible; size L200: 7 pcs. possible

Planter Insert	1 piece	50 x 50 x 18		9003414 16424 6	
	2 piece	50 x 50 x 18		9003414 16427 7	
	3 piece	50 x 50 x 18		9003414 16430 7	
	4 piece	50 x 50 x 18		9003414 16433 8	
Trellis (1 pc.) (With L-size is 1 pc. also possible)	100	102 x 4 x 91	9003414 16436 9	9003414 16438 3	9003414 16437 6
	150	152 x 4 x 91	9003414 16439 0	9003414 16441 3	9003414 16440 6
	200	201 x 4 x 91	9003414 16442 0	9003414 16444 4	9003414 16443 7
Trellis for L Form (2 pcs.) (for each of the long sides)	L100	102 x 102 x 91	9003414 16445 1	9003414 16447 5	9003414 16446 8
	L150	152 x 152 x 91	9003414 16448 2	9003414 16450 5	9003414 16449 9
	L200	201 x 201 x 91	9003414 16451 2	9003414 16453 6	9003414 16452 9
Privacy Screen (1 pc.) (With L-size is 1 pc. also possible)	100	102 x 4 x 91	9003414 16457 4	9003414 16459 8	9003414 16458 1
	150	152 x 4 x 91	9003414 16460 4	9003414 16462 8	9003414 16461 1
	200	201 x 4 x 91	9003414 16463 5	9003414 16465 9	9003414 16464 2
Privacy Screen for L Form (2 pcs.) (for each of the long sides)	L100	102 x 102 x 91	9003414 16466 6	9003414 16468 0	9003414 16467 3
	L150	152 x 152 x 91	9003414 16469 7	9003414 16471 0	9003414 16470 3
	L200	201 x 201 x 91	9003414 16472 7	9003414 16474 1	9003414 16473 4
Privacy Screen with Glass Panels (1 pc.) (With L-size is 1 pc. also possible)	100	102 x 4 x 91	9003414 16475 8	9003414 16477 2	9003414 16476 5
	150	152 x 4 x 91	9003414 16478 9	9003414 16480 2	9003414 16479 6
	200	201 x 4 x 91	9003414 16481 9	9003414 16483 3	9003414 16482 6

\*Volume of soil required. Filling height up to max. 22 cm.

Accessories	For Size	Dimensions W x L x H (cm)	Metallic Silver	Metallic Quartz Grey	Metallic Dark Grey
Privacy Screen with Glass Panel for L Form (2 pcs.) (for each of the long sides)	<b>L100</b>	102 x 102 x 91	9003414 16484 0	9003414 16486 4	9003414 16485 7
	<b>L150</b>	152 x 152 x 91	9003414 16487 1	9003414 16489 5	9003414 16488 8
	<b>L200</b>	201 x 201 x 91	9003414 16490 1	9003414 16492 5	9003414 16491 8
Irrigation System	200 <sup>MAXI</sup>			9003414 <b>95688</b> 9	
Greenhouse Florentina extension	200 <sup>MAXI</sup>	201,6 x 54,8 x 213,4		9003414 95396 3	9003414 95399 4
Only available in combination with the Florentina greenhouse extension.					
Plant Pot Set	200 <sup>MAXI</sup>	16,3 x 16,5 x 128		9003414 <b>95701</b> 5	
Weather Protection Plate	200 <sup>MAXI</sup>	50,2 x 30,2 x 4,7		9003414 <b>95699</b> 5	
Automatic Ventilation	200 <sup>MAXI</sup>	67 x 12,5 x 5,5		9003414 <b>95693</b> 3	
Florentina Trellis	200 <sup>MAXI</sup>	150,8 x 4,2 x 150,8		9003414 <b>95700</b> 8	

DaVinci®	Version	Exterior Dimensions W x L x H (cm)	EAN Code			
			Metallic Silver	Metallic Quartz Grey	Metallic Dark Grey	
	<b>1</b>	Terrace border with trellis: 1.5 m corner with trellis, graduated on both sides 0.5 m MIDI, 1 m MINI	299 x 299 x 168	9003414 17335 4	9003414 17346 0	9003414 17345 3
	<b>2</b>	Terrace border with privacy screen: 1.5 m MAXI with privacy screen, 1 x 1 m corner with trellis on one side, 0.5 m MIDI, 0.5 m MINI	249 x 200 x 168	9003414 17347 7	9003414 17349 1	9003414 17348 4
	<b>3</b>	Flower bed: 0.5 m MINI, 0.5 m MIDI and 1 m MAXI	201 x 53,8 x 77	9003414 17350 7	9003414 17352 1	9003414 17351 4

Configure your own DaVinci planter box system now! [www.biohort.com/configurator](http://www.biohort.com/configurator)

## Greenhouses

Florentina Greenhouse	Size	Exterior Dimensions	Interior Dimensions	Volume	Weight	EAN Code		
		W x L x H (cm)	W x L (cm)	(L)	(kg)	Metallic Silver	Metallic Quartz Grey	Metallic Dark Grey
	<b>2x0,5<sup>MAXI</sup></b>	201,6 x 54,8 x 213,4	193,4 x 45,7 x 206	1,8	100,5		9003414 <b>95400</b> 7	9003414 <b>95399</b> 4
	<b>2x1<sup>MAXI</sup></b>	201,6 x 104 x 213,4	193,4 x 94,9 x 206	3,8	114,6		9003414 <b>95402</b> 1	9003414 <b>95401</b> 4

Accessories	For Size	Dimensions W x L x H (cm)	Metallic Silver	Metallic Quartz Grey	Metallic Dark Grey
Intermediate Floor	2x0.5	196 x 50,8 x 3			9003414 <b>65043</b> 5
	2x1	196 x 100 x 3			9003414 <b>65047</b> 3
Skirting	2x0.5	214 x 66,4 x 6,3	9003414 16382 9	9003414 16384 3	9003414 16383 6
	2x1	214 x 115 x 6,3	9003414 16379 9	9003414 16381 2	9003414 16380 5
Irrigation System	for all sizes			9003414 <b>95688</b> 9	
Plant Pot Set	for all sizes	16,3 x 16,5 x 128		9003414 <b>95701</b> 5	
Weather Protection Plate	2x0.5	50,2 x 30,2 x 4,7		9003414 <b>95699</b> 5	
	2x1	99,5 x 30,2 x 4,7		9003414 <b>95698</b> 8	
Automatic Ventilation	for all sizes	67 x 12,5 x 5,5		9003414 <b>95693</b> 3	
Florentina Trellis	for all sizes	150,8 x 4,2 x 150,8		9003414 <b>95700</b> 8	

## Gardening Helpers

MonAmi®	Exterior Dimensions	Interior Dimensions	Volume	Weight	EAN Code	
	W x L x H (cm)	W x L x H (cm)	(L)	(kg)	Metallic Dark Grey	
	102 x 102 x 84	95 x 95 x 74	667,9	62,9	9003414 <b>65026</b> 8	

Charly®	Size	Exterior Dimensions	Weight	EAN Code
		W x L x H (cm)	(kg)	
	<b>2</b>	78 x 90 x 49	13,5	9003414 <b>68082</b> 1

Biohort

For outdoors,  
forever.

NEW







The product of the year: The Florentina Greenhouse.

 Made in Austria

Your specialist dealer:



follow us:

-  biohort
-  biohort
-  Biohort GmbH
-  Biohort GmbH

Here you can find our  
non-binding recom-  
mended retail prices:



**Biohort GmbH**

Pürnstern 43, 4120  
Neufelden, Austria  
+43 7282 / 7788 0  
office@biohort.at  
www.biohort.com

Technical modifications,  
misprints and colour  
deviations reserved.

ZD031070 – EN

